



KATALOG T23

Ventilatoren, Zyklone & Zellenradschleuse

**LÖSUNGEN FÜR INDUSTRIELLE
STAUBABSAUGUNGEN**

Inhaltsverzeichnis

1. Einführung	2
2. Berechnung Ventilatoren Preis	6
3. Inhaltsverzeichnis	7
4. Niederdruckventilatoren	8
RL CA	
5. Mitteldruckventilatoren	16
RM GF GR RH	
6. Mitteldruckventilatoren - offenes Laufrad	32
ZM ZC	
7. Hochdruckventilatoren	40
VI/N VM VG/N VP/N VC/N VA/P	
8. Hochdruckventilatoren - offenes Laufrad	64
ZA ZB ZD	
9. Ventilatoren in Edelstahlausführung	73
Mehrpreis Mitteldruck Mehrpreis Hochdruck	
10. Ventilatoren Optionen & Zubehör	75
Ventilatoren Ein- und Auslässe Saugzubehör Saugzubehör Rostfrei Ergänzung Druckseite Zubehör Druckseite Zubehör Rostfrei Ergänzung Optionen Vibroisolatoren Ventilatorendichtringe	
11. Motoren	82
Standard Motoren SIEMENS Motoren Motoranbau Motoren ATEX 3GD Motoren ATEX 2G Motoren ATEX 2D Frequenzumrichter	
12. Schalldämmung	86
Schallschutzhaube	
13. Zyklonen	87
FA FS FK	
14. Zellenradschleusen	88
RVA RVB RVD	
15. Abscheideren	89
Abscheider XRUV Flexible Verschluss	
16. Kontaktangaben	90

Einleitung

Formula Air arbeitet mit einem breiten Lüftungsprogramm, das speziell für eine Vielzahl von Anwendungen in allen Industriebranchen mit folgenden Eigenschaften ausgewählt wurde:

- **Reinluftventilatoren für :**
Trocknung, Klimatisierung, Kühlung, Druckbeaufschlagung, Belüftung, und verschiedene Gase, Staubabsaugung.
- **Rohluft- / Transportluftventilatoren für :**
Sägemehl, verschiedene Arten von Spänen, körniges Material, Fasermaterial und pneumatischer Transport oder zentrale Reinigung.
- **Größen :**
220 bis 2000.
- **Motorleistungen :**
0,12 kW bis 250 kW



Standardausführung



Standard Gehäuse :

Pulverbeschichtete Polyester-Elektrostatiklacke mit einer Dicke von 70 Mikrometern, aber auch andere Farben sowie andere Oberflächen sind auf anfrage erhältlich. Alle Modelle sind auch in feuerverzinkt, rostfreier Stahl 1.4306 und 1.4404 erhältlich.

Das Gehäuse ist in Standardausführungen bis zu einer bestimmten Größe gefalzt, darüber hinaus sind sie verschweißt wodurch die Gehäusestellung nicht selbst geändert werden kann.

Standard Laufrad :

Grau lackiert mit einer Dicke von 50 µm, sie sind statisch und dynamisch nach ISO 1940/1 ausgewuchtet.

Standard Farbe :

Ventilator Gehäuse und Motorblock - RAL 5010

Ventilator Schutzvorrichtungen - RAL 2002

Ventilator Laufrad und Zubehör - RAL 9007

Haftungsausschluss

Die genannten Preise verstehen sich ab Werk, exklusive Mehrwertsteuer und in Euro. Die Preise in dieser Preisliste dienen nur zu Informationszwecken und können jederzeit ohne Vorankündigung geändert werden. Bilder der verwendeten Produkte sind 3D-Darstellungen. Kleine Abweichungen sind daher möglich. Lieferbedingungen finden Sie auf unserer Website: www.formula-air.com

Wie Konfiguriere ich richtig

Um den für Ihre Anwendung am besten geeigneten Ventilator richtig zusammen zu stellen wählen Sie bitte folgende nachfolgende einzelne Komponenten aus:

- den Ventilator Typ
- die Ventilator Ausführung Hinweis: alle Riemen betriebene Ventilatoren auf Anfrage erhältlich.
- die eventuell benötigten Optionen
- die Oberflächenveredelung und / oder andere Ergänzungen
- den Motor (Seiten 82) passend zum gewähltem Ventilator und die Montagekosten



Mögliche Gehäusestellung

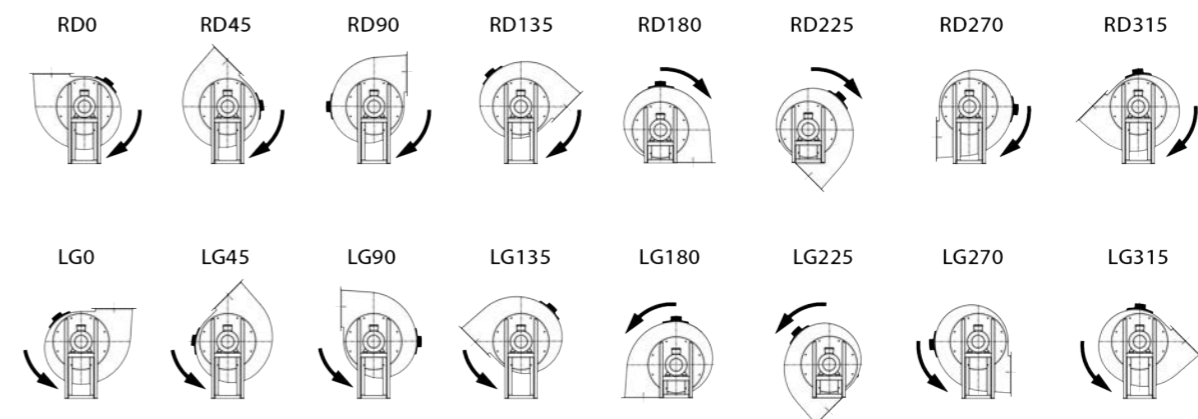

Hinweis: Für die Gehäusestellungen RD/LG 180 und 225 müssen Anpassungen am Ventilator vorgenommen werden die mit einem Mehrpreis von uns extra berechnet werden.

Wählen Sie die Ausführung



Ausführung 1



Ausführung 8



Ausführung 4



Ausführung 9



Ausführung 5



Ausführung 12

Wählbares Zubehör

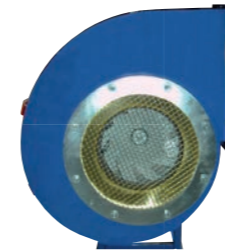

Einlass und Auslassgitter
um zu vermeiden, dass
Fremdkörper in das
Beatmungsgerät gelangen



Einlass- und Auslass-Lamellenklappe
manuelle oder pneumatische Versionen, die den
Luftstrom in den Ventilatoren regulieren und die
Gesamtleistung verbessern



**Einlass und Auslass flexible
Verbindungen**
für saubere oder schmutzige Luft



Schwingungsdämpfer
Verhindern Sie die Übertragung von Vibrationen
in die Gebäudestruktur und reduzieren Sie den
seitlichen und vertikalen Vibrationseffekt

Auch in dieser Preisliste enthalten

In verschiedenen Ausführungen erhältlich :

- Standardstahl pulverbeschichtet
- Feuerverzinkt
- Aluminium
- Rostfrei 1.4306 & 1.4404
- ATEX-zertifiziert



Zellenradschleuse
(Seite 88)

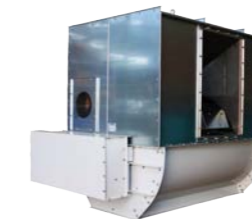

Abscheider
(Seite 89)



Zyclone
(Seite 87)

Berechnung Ventilatoren Preis

Pos.	Beschreibung (Code)
1	Ansauggitter (RETA)
2	Flex-Verbindung (GA1, GA3 or GA6)
3	Ansaugflansch (INF)
4	Einlass
5	Laufrad
6	Umkippschutz (FS)
7	Gehäuse
8	Inspektionklappe (ID)
9	Aufblasflansch (OUF)
10	Flex-Verbindung (GP1, GP3 or GP6)
11	Aufblasgitter (RETEM)
12	Motorbock
13 & 14	Dichtung (TEN)
15	Motor

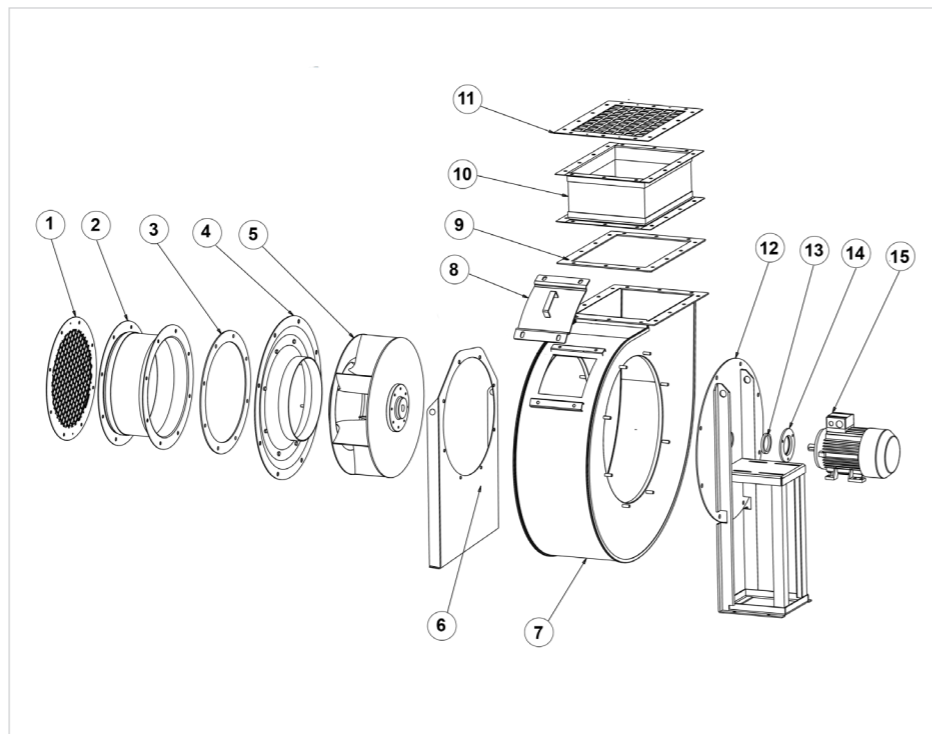

Direkt angetriebene Ventilatoren ex. 4 & 5	Ventilator + Motor + Montage + event. Zubehör.
ATEX Direkt angetriebene Ventilatoren ex. 4 & 5	Ventilator + ATEX ergänzen + Motor + Montage + event. Zubehör.
Direkte Axialventilatoren	Ventilator + Motor + Montage + event. Zubehör.
ATEX Direkte Axialventilatoren	Ventilator + ATEX ergänzen + Motor + Montage + event. Zubehör.
Riemenantrieb Axialventilatoren	Ventilator + Getriebe + Motor + Montage + event. Zubehör.
Edelstahl-Ventilatoren	Standard Ventilator + Edelstahl-Ergänzung (Edelstahl Preisliste).
Zubehör Druck und Ansaugseite	Überprüfen Sie die Größe des Zubehörs des entsprechenden Ventilatormodells in den letzten Spalte in der Tabelle und wählen Sie das passende model aus der Tabelle auf Seite 51 bis 55.
Laufradausführung & Sonderlackierungen	Auf Anfrag

Inhaltsverzeichnis

Symbol	Beschreibung
ID	Inspektionklappe
HT	Heißgas Ausführung max. 150 °C
TEN	NBR Wellendichtung
DP	Ablassschraube
WC	Gerschweißtes Gehäuse
FS	Umkippschutz montiert an der Saugseite
SOS	Umkippschutz montiert am GehÄuse (Hochdruck)
INF	Flansch für Ansaugseite
OUF	Flansch für Druckseite
COL	Doppel Flanschkragen auf der Ansaugseite
CGA	Absaugstütze - mit eine Flansch
GA1	Flex-Verbindung Ansaugseite max. 70 °C
GA3	Flex-Verbindung Ansaugseite max. 200 °C
GAT	Flex-Verbindung mit Teflon beschichtet, Ansaugseite
GAC	Flex-Verbindung Ansaugseite mit Textil Isolierung
RETA	Standard-Gitter auf der Ansaugseite
GA6	Flex-Verbindung mit Sthaleinlage Ansaugseite max. 200 °C (für Transportluft geeignet)
RETSA	Hochdruck -Gitter auf der Ansaugseite
SILC	Schalldämpfer auf Ansaugseite
VALDAP	DAPO klappen (Drallregler)
VALFAR	Regelklappen
COMPN	Pneumatik-Antrieb
COMEL	Elektrischer Antrieb
COMQG	Schwenkantrieb
•	Ab Lager lieferbar

Symbol	Beschreibung
CGP	Ausblastsstütze - mit eine Flansch
GP1	Flex-Verbindung Druckseite max. 70 °C
GP3	Flex-Verbindung Druckseite max. 200 °C
GPT	Flex-Verbindung mit Teflon beschichtet, Druckseite
GPC	Flex-Verbindung Druckseite mit Textil Isolierung
GP6	Flex-Verbindung mit Sthaleinlage Druckseite max. 200 °C (für Transportluft geeignet)
RETM	Standard-Gitter auf der Druckseite
CULS	Manuelle Schieber auf der Druckseite
SILQ	Schalldämpfer am Druckseite
SERML	Lamellenklappe auf der Druckseite
SERMM	Lamellenklappe mit lagern auf der Druckseite
TEN-N	Single NBR Dichtung
TEN-V	Single FPM Dichtung
TEN-S	Single SILICONE Dichtung
TEG	Wirtschaftliche Anti-Staub-Dichtung
T2G	Doppelte Dichtung mit Schmiersperr
T2F	Doppelte Dichtung für Überdruck
T2R	Doppeldichtung für Unterdruck
TEN-G	Single GRAPHITE-Dichtung
TBAD	Dichtung mit Graphite ringe
TBAT	Dichtung mit PTFE-beschichteten Ringen
Extra Tipo C	Ausführung mit funkenfreiem Einlass und Rückwand
C	Inklusive
R	Preise auf Anfrage
N	Nicht verfügbar

RL - Ventilatoren

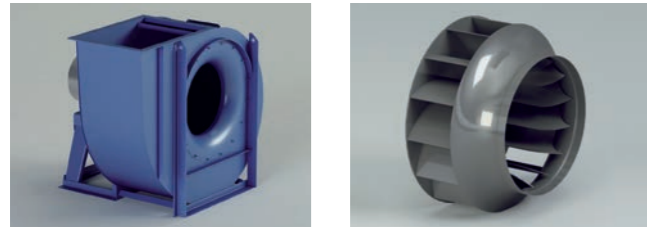

- **Arbeitsbereich :** Mittlere - große Fördermengen. Niedrige Drücke.
- **Lauftrad :** rückwärts gekrümmt, geschlossen.
- **Anwendungen :** Zur Absaugung von Reinluft, auch mit geringem Anteil von Sägestaub, für Anwendungen in Industrieanlagen und zur Klimatisierung in Häusern und Industrie.
- **Technische Spezifikationen :** Luftvolumen : 1.000 bis 270.000 m³/h. Gesamtdruck : 20 bis 460 daPa.

Ventilator	Max-Umdrehungen (rpm)		
	Größe	KLASSE I	KLASSE II
RL250	4000	5000	6000
RL280	3800	4500	5300
RL310	3600	4100	4750
RL350	3250	3700	4250
RL400/R	2950	3300	3900
RL400	2950	3300	3900
RL450/R	2750	3150	3800
RL450	2550	2955	3550
RL500/R	2350	2750	3350
RL500	2250	2600	3150
RL560/R	2100	2450	3000
RL560	2000	2300	2850
RL630/R	1850	2150	2650
RL630	1750	2050	2500
RL710/R	1900	2300	2550

Ventilator	Max-Umdrehungen (rpm)		
	Größe	KLASSE I	KLASSE II
RL710	1800	2200	2400
RL800/R	1700	2050	2300
RL800	1600	1950	2150
RL900/R	1500	1850	2000
RL900	1450	1750	1900
RL1000/R	1350	1650	1800
RL1000	1250	1550	1700
RL1120/R	1250	1350	1450
RL1120	1200	1300	1400
RL1250/R	1150	1250	1350
RL1250	1100	1200	1300
RL1400/R	1050	1150	1250
RL1400	1000	1100	1200
RL1600	900	1000	1100
RL1800	800	900	1000

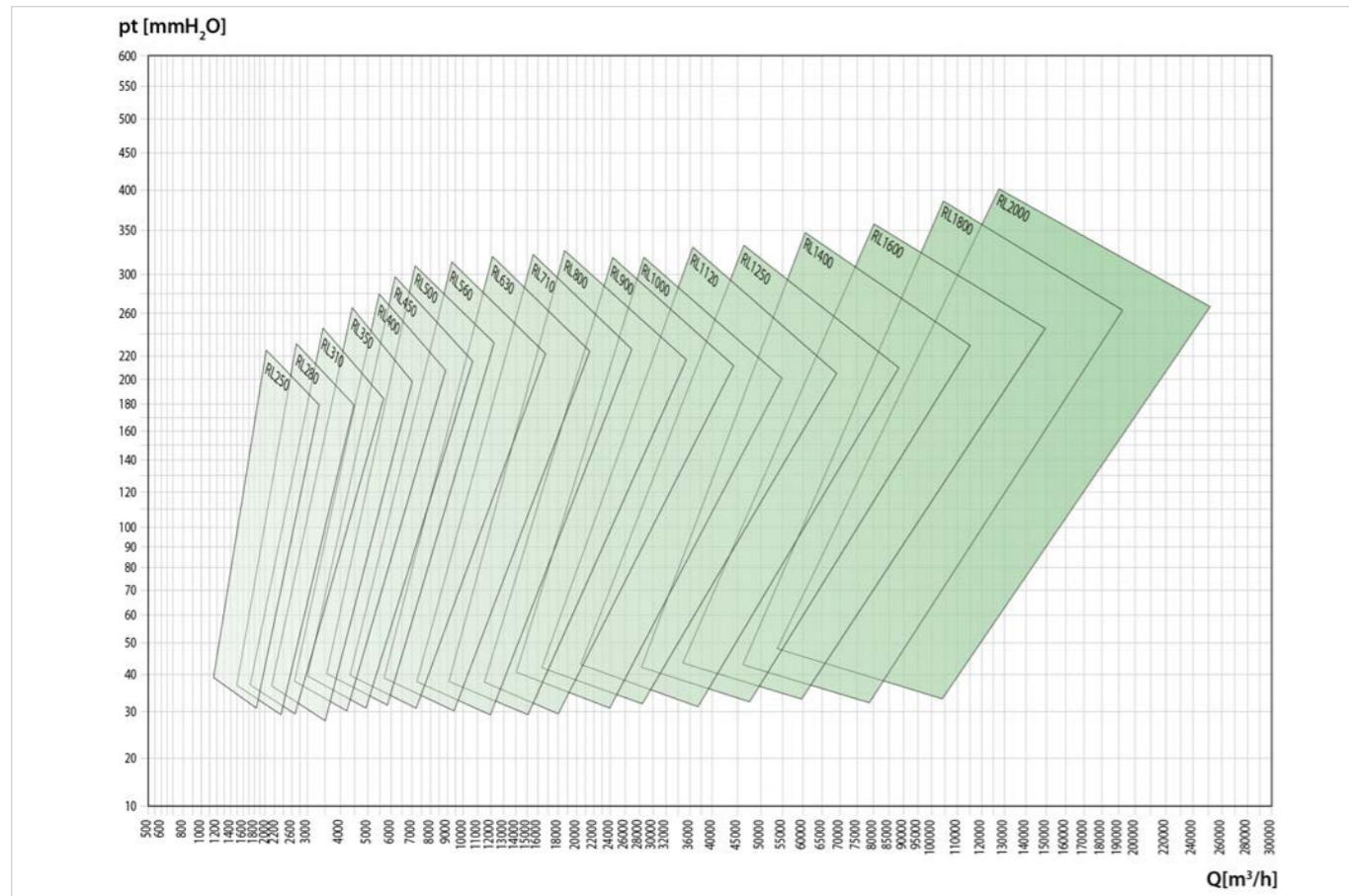

Typ	Gr	kW	Pole	EX4		EX5		ID		HT	
				Code	Preis	Code	Preis	Code	Preis	Code	Preis
RL250/2	71	0,55	2	HBAA000001	463 €	HBAB000001	435 €	HDCA000001	57 €	HDEA000001	111 €
RL280/2	80	1,1	2	HBAA000017	540 €	HBAB000002	510 €	HDCA000002	57 €	HDEA000002	111 €
RL310/4	63	0,18	4	HBAA000161	669 €	HBAB000011	636 €	HDCA000011	64 €	N	N
RL310/2	90	2,2	2	HBAA000033	669 €	HBAB000003	636 €	HDCA000003	64 €	HDEA000003	174 €
RL350/4	71	0,37	4	HBAA000177	792 €	HBAB000012	755 €	HDCA000012	64 €	HDEA000011	111 €
RL350/2	100	3	2	HBAA000049	858 €	HBAB000004	847 €	HDCA000004	64 €	HDEA000004	174 €
RL400/4R	80	0,55	4	HBAA000193	946 €	HBAB000013	902 €	HDCA000013	73 €	HDEA000012	111 €
RL400/4	80	0,75	4	HBAA000209	946 €	HBAB000014	902 €	HDCA000014	73 €	HDEA000013	111 €
RL400/2R	112	4	2	HBAA000065	1,021 €	HBAB000005	1,002 €	HDCA000005	73 €	HDEA000005	174 €
RL400/2	132	5,5	2	HBAA000081	1,021 €	HBAB000006	1,002 €	HDCA000006	73 €	HDEA000006	276 €
RL450/4R	80	0,75	4	HBAA000225	1,113 €	HBAB000015	1,061 €	HDCA000015	73 €	HDEA000014	111 €
RL450/4	90	1,1	4	HBAA000241	1,113 €	HBAB000016	1,061 €	HDCA000016	73 €	HDEA000015	174 €
RL450/2R	132	7,5	2	HBAA000097	1,196 €	HBAB000007	1,169 €	HDCA000007	73 €	HDEA000007	276 €
RL450/2	160	11	2	HBAA000113	1,240 €	HBAB000008	1,221 €	HDCA000008	73 €	HDEA000008	276 €
RL500/6R	80	0,37	6	HBAA000481	1,319 €	HBAB000031	1,250 €	HDCA000031	90 €	HDEA000030	111 €
RL500/6	80	0,55	6	HBAA000497	1,319 €	HBAB000032	1,250 €	HDCA000032	90 €	HDEA000031	111 €
RL500/4R	90	1,5	4	HBAA000257	1,319 €	HBAB000017	1,250 €	HDCA000017	90 €	HDEA000016	174 €
RL500/4	100	2,2	4	HBAA000273	1,319 €	HBAB000018	1,250 €	HDCA000018	90 €	HDEA000017	174 €
RL500/2R	160	15	2	HBAA000129	1,572 €	HBAB000009	1,366 €	HDCA000009	90 €	HDEA000009	276 €
RL500/2	160	18,5	2	HBAA000145	1,572 €	HBAB000010	1,366 €	HDCA000010	90 €	HDEA000010	276 €
RL560/6R	90	0,75	6	HBAA000513	1,648 €	HBAB000033	1,473 €	HDCA000033	113 €	HDEA000032	174 €
RL560/6	90	1,1	6	HBAA000529	1,648 €	HBAB000034	1,473 €	HDCA000034	113 €	HDEA000033	174 €
RL560/4R	100	3	4	HBAA000289	1,648 €	HBAB000019	1,473 €	HDCA000019	113 €	HDEA000018	174 €
RL560/4	112	4	4	HBAA000305	1,648 €	HBAB000020	1,473 €	HDCA000020	113 €	HDEA000019	174 €
RL630/6R	100	1,5	6	HBAA000545	1,984 €	HBAB000035	2,038 €	HDCA000035	113 €	HDEA000034	174 €
RL630/6	112	2,2	6	HBAA000561	1,984 €	HBAB000036	2,038 €	HDCA000036	113 €	HDEA000035	174 €
RL630/4R	132	5,5	4	HBAA000321	1,984 €	HBAB000021	2,038 €	HDCA000021	113 €	HDEA000020	276 €
RL630/4	132	7,5	4	HBAA000337	1,984 €	HBAB000022	2,038 €	HDCA000022	113 €	HDEA000021	276 €
RL710/6R	132	3	6	HBAA000577	2,479 €	HBAB000037	2,468 €	HDCA000037	113 €	HDEA000036	276 €
RL710/6	132	4	6	HBAA000593	2,479 €	HBAB000038	2,468 €	HDCA000038	113 €	HDEA000037	276 €
RL710/4R	160	11	4	HBAA000353	2,479 €	HBAB000023	2,468 €	HDCA000023	113 €	HDEA000022	276 €
RL710/4	160	15	4	HBAA000369	2,479 €	HBAB000024	2,468 €	HDCA000024	113 €	HDEA000023	276 €
RL800/6R	132	5,5	6	HBAA000609	3,171 €	HBAB000039	3,174 €	HDCA000039	113 €	HDEA000038	276 €
RL800/6	160	7,5	6	HBAA000625	3,171 €	HBAB000040	3,174 €	HDCA000040	113 €	HDEA000039	276 €
RL800/4R	180	18,5	4	HBAA000385	3,171 €	HBAB000025	3,174 €	HDCA000025	113 €	HDEA000024	276 €
RL800/4	180	22	4	HBAA000401	3,171 €	HBAB000026	3,174 €	HDCA000026	113 €	HDEA000025	276 €
RL900/6R	160	11	6	HBAA000641	4,416 €	HBAB000041	4,532 €	HDCA000041	C	HDEA000040	276 €
RL900/6	180	15	6	HBAA000657	4,416 €	HBAB000042	4,532 €	HDCA000042	C	HDEA000041	276 €
RL900/4R	225	37	4	HBAA000417	4,631 €	HBAB000027	4,722 €	HDCA000027	C	HDEA000026	368 €
RL900/4	225	45	4	HBAA000433	4,631 €	HBAB000028	5,034 €	HDCA000028	C	HDEA000027	368 €
RL1000/6R	200	18,5	6	HBAA000673	5,366 €	HBAB000043	5,540 €	HDCA000043	C	HDEA000042	368 €
RL1000/6	200	22	6	HBAA000689	5,366 €	HBAB000044	5,540 €	HDCA000044	C	HDEA000043	368 €
RL1000/4R	250	55	4	HBAA000449	5,953 €	HBAB000029	5,930 €	HDCA000029	C	HDEA000028	368 €
RL1000/4	280	75	4	HBAA000465	6,434 €	HBAB000030	6,525 €	HDCA000030	C	HDEA000029	431 €
RL1120/6R	225	30	6	HBAA000705	7,193 €	HBAB000045	7,447 €	HDCA000045	C	HDEA000044	368 €
RL1120/6	250	37	6	HBAA000721	7,193 €	HBAB000046	7,447 €	HDCA000046	C	HDEA000045	368 €
RL1250/6R	280	55	6	HBAA000737	9,507 €	N	N	HDCA000048	C	HDEA000047	431 €
RL1250/6	315	75	6	HBAA000753	9,507 €	N	N	HDCA000047	C	HDEA000046	431 €
RL1400/6R	315	90	6	HBAA000769	11,530 €	N	N	HDCA000050	C	HDEA000049	431 €
RL1400/6	315	110	6	HBAA000785	11,530 €	N	N	HDCA000049	C	HDEA000048	431 €

Typ	TEN		DP		WC		FS		Extra 2GD EX.4	
	Code	Preis	Code	Preis	Code	Preis	Code	Preis	Code	Preis
RL250/2	HGBA000001	111 €	HDDA000001	49 €	HDBA000001	112 €	HDAA000001	76 €	HEDA000001	578 €
RL280/2	HGBA000002	111 €	HDDA000002	49 €	HDBA000002	123 €	HDAA000002	76 €	HEDA000002	622 €
RL310/4	N	N	HDDA000011	49 €	HDBA000011	137 €	HDAA000011	80 €	HEDA000011	724 €
RL310/2	HGBA000003	174 €	HDDA000003	49 €	HDBA000003	137 €	HDAA000003	80 €	HEDA000003	724 €
RL350/4	HGBA000011	111 €	HDDA000012	49 €	HDBA000012	167 €	HDAA000012	91 €	HEDA000012	715 €
RL350/2	HGBA000004	174 €	HDDA000004	49 €	HDBA000004	167 €	HDAA000004	91 €	HEDA000004	778 €
RL400/4R	HGBA000012	111 €	HDDA000013	49 €	HDBA000013	167 €	HDAA000013	92 €	HEDA000013	791 €
RL400/4	HGBA000013	111 €	HDDA000014	49 €	HDBA000014	167 €	HDAA000014	92 €	HEDA000014	791 €
RL400/2R	HGBA000005	174 €	HDDA000005	49 €	HDBA000005	167 €	HDAA000005	92 €	HEDA000005	854 €
RL400/2	HGBA000006	174 €	HDDA000006	49 €	HDBA000006	167 €	HDAA000006	92 €	HEDA000006	956 €
RL450/4R	HGBA000014	111 €	HDDA000015	49 €	HDBA000015	207 €	HDAA000015	101 €	HEDA000015	847 €
RL450/4	HGBA000015	174 €	HDDA000016	49 €	HDBA000016	207 €	HDAA000016	101 €	HEDA000016	910 €
RL450/2R	HGBA000007	276 €	HDDA000007	49 €	HDBA000007	207 €	HDAA000007	101 €	HEDA000007	1,012 €
RL450/2	HGBA000008	276 €	HDDA000008	49 €	HDBA000008	207 €	HDAA000008	101 €	HEDA000008	1,012 €
RL500/6R	HGBA000030	174 €	HDDA000031	49 €	HDBA000031	234 €	HDAA000031	108 €	HEDA000031	895 €
RL500/6	HGBA000031	174 €	HDDA000032	49 €	HDBA000032	234 €	HDAA000032	108 €	HEDA000032	895 €
RL500/4R	HGBA000016	174 €	HDDA000017	49 €	HDBA000017	234 €	HDAA000017	108 €	HEDA000017	958 €
RL500/4	HGBA000017	174 €	HDDA000018	49 €	HDBA000018	234 €	HDAA000018	108 €	HEDA000018	958 €
RL500/2R	HGBA000009	276 €	HDDA000009	49 €	HDBA000009	234 €	HDAA000009	C	HEDA000009	1,060 €
RL500/2	HGBA000010	276 €	HDDA000010	49 €	HDBA000010	234 €	HDAA000010	C	HEDA000010	1,060 €
RL560/6R	HGBA000032	174 €	HDDA000033	49 €	HDBA000033	262 €	HDAA000033	C	HEDA000033	1,123 €
RL560/6	HGBA000033	174 €	HDDA000034	49 €	HDBA000034	262 €	HDAA000034	C	HEDA000034	1,123 €
RL560/4R	HGBA000018	174 €	HDDA000019	49 €	HDBA000019	262 €	HDAA000019	C	HEDA000019	1,123 €
RL560/4	HGBA000019	174 €	HDDA000020	49 €	HDBA000020	262 €	HDAA000020	C	HEDA000020	1,123 €
RL630/6R	HGBA000034	174 €	HDDA000035	49 €	HDBA000035	290 €	HDAA000035	C	HEDA000035	1,186 €
RL630/6	HGBA000035	174 €	HDDA000036	49 €	HDBA000036	290 €	HDAA000036	C	HEDA000036	1,186 €
RL630/4R	HGBA000020	276 €	HDDA000021	49 €	HDBA000021	290 €	HDAA000021	C	HEDA000021	1,288 €
RL630/4	HGBA000021	276 €	HDDA000022	49 €	HDBA000022	290 €	HDAA000022	C	HEDA000022	1,288 €
RL710/6R	HGBA000036	276 €	HDDA000037	78 €	HDBA000037	400 €	HDAA000037	C	HEDA000037	1,425 €
RL710/6	HGBA000037	276 €	HDDA000038	78 €	HDBA000038	400 €	HDAA000038	C	HEDA000038	1,425 €
RL710/4R	HGBA000022	276 €	HDDA000023	78 €	HDBA000023	400 €	HDAA000023	C	HEDA000023	1,425 €
RL710/4	HGBA000023	276 €	HDDA000024	78 €	HDBA000024	400 €	HDAA000024	C	HEDA000024	1,425 €
RL800/6R	HGBA000038	276 €	HDDA000039	78 €	HDBA000039	469 €	HDAA000039	C	HEDA000039	1,600 €
RL800/6	HGBA000039	276 €	HDDA000040	78 €	HDBA000040	469 €	HDAA000040	C	HEDA000040	1,600 €
RL800/4R	HGBA000024	276 €	HDDA000025	78 €	HDBA000025	469 €	HDAA000025	C	HEDA000025	1,600 €
RL800/4	HGBA000025	276 €	HDDA000026	78 €	HDBA000026	469 €	HDAA000026	C	HEDA000026	1,600 €
RL900/6R	HGBA000040	276 €	HDDA000041	78 €	HDBA000041	C	HDAA000041	C	HEDA000041	1,065 €
RL900/6	HGBA000041	276 €	HDDA000042	78 €	HDBA000042	C	HDAA000042	C	HEDA000042	1,065 €
RL900/4R	HGBA000026	368 €	HDDA000027	78 €	HDBA000027	C	HDAA000027	C	HEDA000027	1,158 €
RL900/4	HGBA000027	368 €	HDDA000028	78 €	HDBA000028	C	HDAA000028	C	HEDA000028	1,158 €
RL1000/6R	HGBA000042	368 €	HDDA000043	78 €	HDBA000043	C	HDAA000043	C	HEDA000043	1,390 €
RL1000/6	HGBA000043	368 €	HDDA000044	78 €	HDBA000044	C	HDAA000044	C	HEDA000044	1,390 €
RL1000/4R	HGBA000028	368 €	HDDA000029	78 €	HDBA000029	C	HDAA000029	C	HEDA000029	1,369 €
RL1000/4	HGBA000029	431 €	HDDA000030	78 €	HDBA000030	C	HDAA000030	C	HEDA000030	1,432 €
RL1120/6R	HGBA000044	368 €	HDDA000045	78 €	HDBA000045	C	HDAA000045	C	HEDA000045	1,786 €
RL1120/6	HGBA000045	368 €	HDDA000046	78 €	HDBA000046	C	HDAA000046	C	HEDA000046	1,786 €
RL1250/6R	HGBA000046	431 €	HDDA000048	78 €	HDBA000048	C	HDAA000048	C	HEDA000047	2,001 €
RL1250/6	HGBA000047	431 €	HDDA000047	78 €	HDBA000047	C	HDAA000047	C	HEDA000048	2,001 €
RL1400/6R	HGBA000048	431 €	HDDA000050	129 €	HDBA000050	C	HDAA000050	C	HEDA000049	2,512 €
RL1400/6	HGBA000049	431 €	HDDA000049	129 €	HDBA000049	C	HDAA000049	C	HEDA000050	2,512 €

Typ	Extra 2GD EX.5		Extra 3GD EX.4		Extra 3GD EX.5		Extra Tipo C EX.4		Extra Tipo C EX.5	
	Code	Preis	Code	Preis	Code	Preis	Code	Preis	Code	Preis
RL250/2	HEDA000429	461 €	HEGA000001	347 €	HEGA000427	230 €	HEAA000001	141 €	HEAA000429	134 €
RL280/2	HEDA000430	517 €	HEGA000002	379 €	HEGA000428	274 €	HEAA000002	164 €	HEAA000430	169 €
RL310/4	HEDA000439	542 €	N	N	HEGA000437	286 €	N	N	HEAA000439	174 €
RL310/2	HEDA000431	556 €	HEGA000003	468 €	HEGA000429	300 €	HEAA000003	182 €	HEAA000431	188 €
RL350/4	HEDA000440	594 €	HEGA000011	430 €	HEGA000438	308 €	HEAA000011	206 €	HEAA000440	195 €
RL350/2	HEDA000432	641 €	HEGA000004	493 €	HEGA000430	356 €	HEAA000004	206 €	HEAA000432	242 €
RL400/4R	HEDA000441	658 €	HEGA000012	505 €	HEGA000439	372 €	HEAA000012	253 €	HEAA000441	190 €
RL400/4	HEDA000442	658 €	HEGA000013	505 €	HEGA000440	372 €	HEAA000013	253 €	HEAA000442	231 €
RL400/2R	HEDA000433	692 €	HEGA000005	568 €	HEGA000431	406 €	HEAA000005	253 €	HEAA000433	265 €
RL400/2	HEDA000434	713 €	HEGA000006	671 €	HEGA000432	427 €	HEAA000006	253 €	HEAA000434	286 €
RL450/4R	HEDA000443	745 €	HEGA000014	521 €	HEGA000441	419 €	HEAA000014	266 €	HEAA000443	241 €
RL450/4	HEDA000444	745 €	HEGA000015	584 €	HEGA000442	419 €	HEAA000015	266 €	HEAA000444	241 €
RL450/2R	HEDA000435	766 €	HEGA000007	686 €	HEGA000433	440 €	HEAA000007	266 €	HEAA000435	295 €
RL450/2	HEDA000436	790 €	HEGA000008	893 €	HEGA000434	671 €	HEAA000008	266 €	HEAA000436	319 €
RL500/6R	HEDA000457	759 €	HEGA000030	406 €	HEGA000455	406 €	HEAA000030	270 €	HEAA000457	245 €
RL500/6	HEDA000458	759 €	HEGA000031	406 €	HEGA000456	406 €	HEAA000031	270 €	HEAA000458	245 €
RL500/4R	HEDA000445	759 €	HEGA000016	605 €	HEGA000443	406 €	HEAA000016	270 €	HEAA000445	245 €
RL500/4	HEDA000446	792 €	HEGA000017	605 €	HEGA000444	440 €	HEAA000017	270 €	HEAA000446	279 €
RL500/2R	HEDA000437	837 €	HEGA000009	941 €	HEGA000435	718 €	HEAA000009	270 €	HEAA000437	323 €
RL500/2	HEDA000438	837 €	HEGA000010	941 €	HEGA000436	718 €	HEAA000010	270 €	HEAA000438	323 €
RL560/6R	HEDA000459	872 €	HEGA000032	742 €	HEGA000457	491 €	HEAA000032	367 €	HEAA000459	290 €
RL560/6	HEDA000460	872 €	HEGA000033	742 €	HEGA000458	491 €	HEAA000033	367 €	HEAA000460	290 €
RL560/4R	HEDA000447	906 €	HEGA000018	742 €	HEGA000445	525 €	HEAA000018	367 €	HEAA000447	323 €
RL560/4	HEDA000448	906 €	HEGA000019	742 €	HEGA000446	525 €	HEAA000019	367 €	HEAA000448	323 €
RL630/6R	HEDA000461	967 €	HEGA000034	777 €	HEGA000459	559 €	HEAA000034	400 €	HEAA000461	356 €
RL630/6	HEDA000462	967 €	HEGA000035	777 €	HEGA000460	559 €	HEAA000035	400 €	HEAA000462	356 €
RL630/4R	HEDA000449	988 €	HEGA000020	879 €	HEGA000447	580 €	HEAA000020	400 €	HEAA000449	377 €
RL630/4	HEDA000450	988 €	HEGA000021	879 €	HEGA000448	580 €	HEAA000021	400 €	HEAA000450	377 €
RL710/6R	HEDA000463	1,120 €	HEGA000036	906 €	HEGA000461	601 €	HEAA000036	424 €	HEAA000463	395 €
RL710/6	HEDA000464	1,120 €	HEGA000037	906 €	HEGA000462	601 €	HEAA000037	424 €	HEAA000464	395 €
RL710/4R	HEDA000451	1,144 €	HEGA000022	1,306 €	HEGA000449	1,025 €	HEAA000022	424 €	HEAA000451	419 €
RL710/4	HEDA000452	1,144 €	HEGA000023	1,306 €	HEGA000450	1,025 €	HEAA000023	424 €	HEAA000452	419 €
RL800/6R	HEDA000465	1,210 €	HEGA000038	1,012 €	HEGA000463	622 €	HEAA000038	514 €	HEAA000465	399 €
RL800/6	HEDA000466	1,233 €	HEGA000039	1,012 €	HEGA000464	645 €	HEAA000039	514 €	HEAA000466	423 €
RL800/4R	HEDA000453	1,233 €	HEGA000024	1,481 €	HEGA000451	1,114 €	HEAA000024	514 €	HEAA000453	423 €
RL800/4	HEDA000454	1,233 €	HEGA000025	1,481 €	HEGA000452	1,114 €	HEAA000025	514 €	HEAA000454	423 €
RL900/6R	HEDA000467	697 €	HEGA000040	946 €	HEGA000465	578 €	HEAA000040	561 €	HEAA000467	469 €
RL900/6	HEDA000468	697 €	HEGA000041	946 €	HEGA000466	578 €	HEAA000041	561 €	HEAA000468	469 €
RL900/4R	HEDA000455	759 €	HEGA000026	1,039 €	HEGA000453	640 €	HEAA000026	561 €	HEAA000455	531 €
RL900/4	HEDA000456	759 €	HEGA000027	1,039 €	HEGA000454	640 €	HEAA000027	561 €	HEAA000456	531 €
RL1000/6R	HEDA000469	778 €	HEGA000042	1,250 €	HEGA000467	659 €	HEAA000042	741 €	HEAA000469	518 €
RL1000/6	HEDA000470	778 €	HEGA000043	1,250 €	HEGA000468	659 €	HEAA000043	741 €	HEAA000470	518 €
RL1000/4R	N	N	HEGA000028	1,250 €	N	N	HEAA000028	741 €	N	N
RL1000/4	N	N	HEGA000029	1,313 €	N	N	HEAA000029	741 €	N	N
RL1120/6R	HEDA000471	848 €	HEGA000044	1,646 €	HEGA000469	729 €	HEAA000044	1,135 €	HEAA000471	587 €
RL1120/6	N	N	HEGA000045	1,646 €	N	N	HEAA000045	1,135 €	N	N
RL1250/6R	N	N	HEGA000046	1,861 €	N	N	HEAA000046	1,2		

CA - Ventilatoren

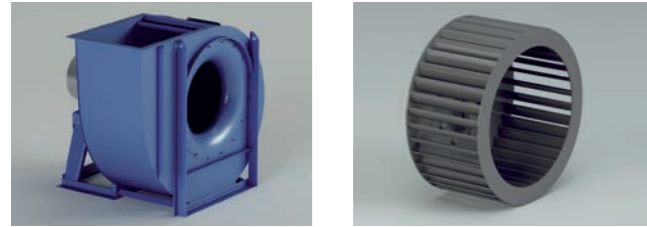

- **Arbeitsbereich :**
Große Fördermengen / Mittlere-Niedrige Drücke.
- **Lauftrad :**
Trommelläufer
- **Anwendungen :**
Zur Absaugung von Reinluft, Dämpfen, für den Transport von sehr großen Luftmengen mit geringen Drücken
- **Technische Spezifikationen :**
Luftvolumen : 700 bis 80.000 m³/h.
Gesamtdruck : 25 bis 285 daPa

Ventilator Größe	Max-Umdrehungen (rpm)		
	KLASSE I	KLASSE II	KLASSE III
CA180	3700*	4200	-
CA200	3300*	3800	4250
CA220	3000*	3450	3800
CA250	2650*	3000	3550
CA280	2350*	2700	3100
CA310	2100*	2450	2750
CA350	2150*	2400	2650
CA400	1900*	2150	2350

Ventilator Größe	Max-Umdrehungen (rpm)		
	KLASSE I	KLASSE II	KLASSE III
CA450	1650*	1900	2100
CA500	-	1700	1900
CA560	-	1500	1650
CA630	-	1300	1450
CA710	-	1200	1300
CA800	-	1000	1150
CA900	-	900	1050
CA1000	-	900	1000

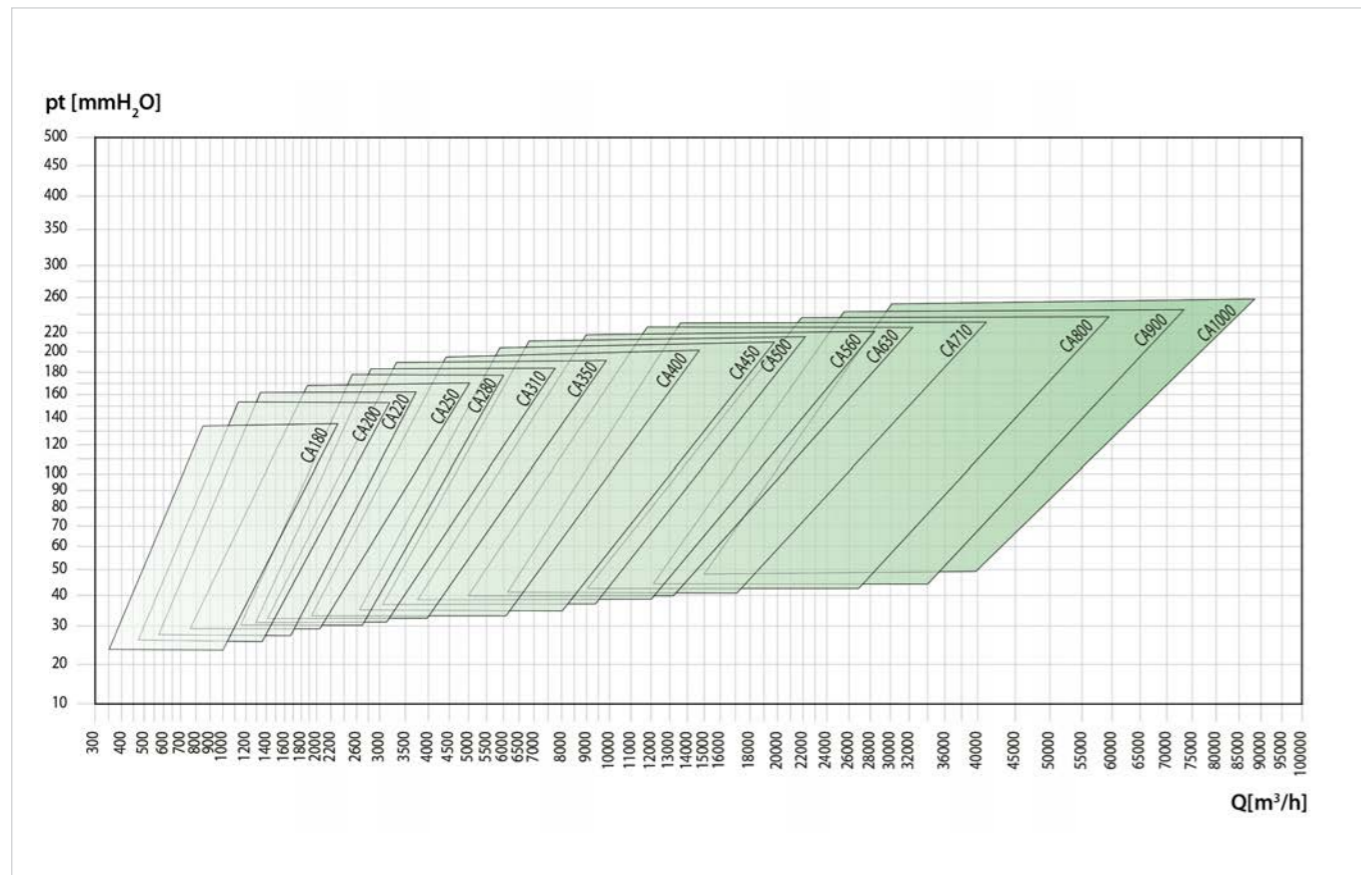

* Gekrampte Laufräder

Typ	Gr	kW	Pole	EX4		EX5		ID		HT	
				Code	Preis	Code	Preis	Code	Preis	Code	Preis
CA180/2	71	0,55	2	HBAA004391	276 €	HBAB000256	263 €	HDCA000276	57 €	HDEA000277	134 €
CA200/2	80	1,1	2	HBAA004407	342 €	HBAB000257	328 €	HDCA000277	57 €	HDEA000278	134 €
CA220/2	90	1,5	2	HBAA004439	370 €	HBAB000258	350 €	HDCA000278	57 €	HDEA000280	196 €
CA220/4	63	0,18	4	HBAA004503	370 €	HBAB000261	350 €	HDCA000281	57 €	HDEA000284	134 €
CA250/2	100	3	2	HBAA004471	553 €	HBAB000260	540 €	HDCA000280	57 €	HDEA000281	174 €
CA250/4	71	0,37	4	HBAA004519	427 €	HBAB000262	399 €	HDCA000282	57 €	HDEA000285	167 €
CA280/2	132	5,5	2	HBAA004487	617 €	N	N	N	N	HDEA000283	276 €
CA280/4	80	0,75	4	HBAA004535	473 €	HBAB000263	442 €	HDCA000283	57 €	HDEA000286	216 €
CA310/4	90	1,5	4	HBAA004551	511 €	HBAB000264	477 €	HDCA000284	64 €	HDEA000288	237 €
CA310/6	80	0,37	6	HBAA004663	511 €	HBAB000273	477 €	HDCA000290	64 €	HDEA000295	178 €
CA350/4	100	2,2	4	HBAA004567	665 €	HBAB000265	627 €	HDCA000285	64 €	HDEA000289	174 €
CA350/6	90	0,75	6	HBAA004679	665 €	HBAB000274	627 €	HDCA000291	64 €	HDEA000296	174 €
CA400/4	132	5,5	4	HBAA004583	819 €	HBAB000266	774 €	HDCA000286	73 €	HDEA000290	276 €
CA400/6	100	1,5	6	HBAA004695	819 €	HBAB000275	774 €	HDCA000292	73 €	HDEA000297	276 €
CA450/4	132	7,5	4	HBAA004599	1,014 €	HBAB000267	962 €	HDCA000287	73 €	HDEA000291	276 €
CA450/6	132	3	6	HBAA004711	1,014 €	HBAB000276	962 €	HDCA000293	73 €	HDEA000298	276 €
CA500/4	160	15	4	HBAA004631	1,509 €	HBAB000269	1,602 €	HDCA000288	90 €	HDEA000292	276 €
CA500/6	132	4	6	HBAA004727	1,235 €	HBAB000277	1,166 €	HDCA000294	90 €	HDEA000299	276 €
CA560/4	180	22	4	HBAA004647	1,959 €	HBAB000271	1,967 €	HDCA000289	113 €	HDEA000293	368 €
CA560/6	160	7,5	6	HBAA004743	1,644 €	HBAB000278	1,691 €	HDCA000295	113 €	HDEA000300	276 €
CA630/6	160	11	6	HBAA004759	2,142 €	HBAB000279	2,248 €	HDCA000296	113 €	HDEA000301	368 €
CA710/6	200	22	6	HBAA004775	3,143 €	N	N	HDCA000297	C	HDEA000303	368 €
CA800/6	250	37	6	HBAA004791	4,024 €	N	N	HDCA000298	C	HDEA000304	368 €
CA900/8	280	45	8	HBAA004807	5,645 €	N	N	HDCA000299	C	HDEA000305	431 €
CA1000/8	315	55	8	HBAA004823	6,667 €	N	N	HDCA000300	C	HDEA000306	431 €

Typ	TEN		DP		WC		FS		Extra 2GD EX.4	
	Code	Preis	Code	Preis	Code	Preis	Code	Preis	Code	Preis
CA180/2	HGBA000280	111 €	HDDA000276	49 €	HDBA000277	99 €	HDAA000275	67 €	HEDA000275	186 €
CA200/2	HGBA000281	111 €	HDDA000277	49 €	HDBA000278	99 €	HDAA000276	67 €	HEDA000276	186 €
CA220/2	HGBA000283	174 €	HDDA000278	49 €	HDBA000279	99 €	HDAA000277	74 €	HEDA000277	193 €
CA220/4	N	N	HDDA000281	49 €	HDBA000282	99 €	HDAA000280	74 €	HEDA000280	193 €
CA250/2	HGBA000284	174 €	HDDA000280	49 €	HDBA000281	112 €	HDAA000279	76 €	HEDA000278	195 €
CA250/4	HGBA000287	111 €	HDDA000282	49 €	HDBA000283	112 €	HDAA000281	76 €	HEDA000281	195 €
CA280/2	HGBA000286	276 €	N	N	N	N	HDAA000433	76 €	HEDA000279	195 €
CA280/4	HGBA000288	111 €	HDDA000283	49 €	HDBA000284	123 €	HDAA000282	76 €	HEDA000282	195 €
CA310/4	HGBA000290	174 €	HDDA000284	49 €	HDBA000285	137 €	HDAA000283	80 €	HEDA000283	199 €
CA310/6	HGBA000297	111 €	HDDA000290	49 €	HDBA000291	137 €	HDAA000290	80 €	HEDA000289	199 €
CA350/4	HGBA000291	174 €	HDDA000285	49 €	HDBA000286	167 €	HDAA000284	91 €	HEDA000284	210 €
CA350/6	HGBA000298	174 €	HDDA000291	49 €	HDBA000292	167 €	HDAA000291	91 €	HEDA000290	210 €
CA400/4	HGBA000292	276 €	HDDA000286	49 €	HDBA000287	167 €	HDAA000285	92 €	HEDA000285	211 €
CA400/6	HGBA000299	174 €	HDDA000292	49 €	HDBA000293	167 €	HDAA000292	92 €	HEDA000291	211 €
CA450/4	HGBA000293	276 €	HDDA000287	49 €	HDBA000288	207 €	HDAA000286	101 €	HEDA000286	220 €
CA450/6	HGBA000300	276 €	HDDA000293	49 €	HDBA000294	207 €	HDAA000293	101 €	HEDA000292	220 €
CA500/4	HGBA000294	276 €	HDDA000288	49 €	HDBA000289	234 €	HDAA000287	108 €	HEDA000287	227 €
CA500/6	HGBA000301	276 €	HDDA000294	49 €	HDBA000295	234 €	HDAA000294	108 €	HEDA000293	227 €
CA560/4	HGBA000295	276 €	HDDA000289	49 €	HDBA000290	262 €	HDAA000288	C	HEDA000288	119 €
CA560/6	HGBA000302	276 €	HDDA000295	49 €	HDBA000296	262 €	HDAA000295	C	HEDA000294	119 €
CA630/6	HGBA000303	276 €	HDDA000296	49 €	HDBA000297	290 €	HDAA000296	C	HEDA000295	119 €
CA710/6	HGBA000305	368 €	HDDA000297	78 €	HDBA000298	C	HDAA000297	C	HEDA000296	119 €
CA800/6	HGBA000306	368 €	HDDA000298	78 €	HDBA000300	C	HDAA000299	C	HEDA000297	119 €
CA900/8	HGBA000307	431 €	HDDA000299	78 €	HDBA000301	C	HDAA000300	C	HEDA000298	119 €
CA1000/8	HGBA000308	431 €	HDDA000300	78 €	HDBA000302	C	HDAA000301	C	HEDA000299	140 €

Typ	Extra 2GD EX.5		Extra 3GD EX.4		Extra 3GD EX.5		Extra Tipo C EX.4		Extra Tipo C EX.5	
	Code	Preis	Code	Preis	Code	Preis	Code	Preis	Code	Preis
CA180/2	HEDA000648	574 €	HEGA000273	356 €	HEGA000646	511 €	HEAA000275	127 €	HEAA000651	127 €
CA200/2	HEDA000649	638 €	HEGA000274	356 €	HEGA000647	511 €	HEAA000276	127 €	HEAA000652	127 €
CA220/2	HEDA000650	641 €	HEGA000275	420 €	HEGA000648	557 €	HEAA000277	130 €	HEAA000653	130 €
CA220/4	N	N	HEGA000278	358 €	HEGA000650	307 €	HEAA000280	130 €	HEAA000655	130 €
CA250/2	HEDA000651	787 €	HEGA000276	410 €	HEGA000649	532 €	HEAA000278	141 €	HEAA000654	141 €
CA250/4	HEDA000653	634 €	HEGA000279	403 €	HEGA000651	358 €	HEAA000281	141 €	HEAA000656	141 €
CA280/2	N	N	HEGA000277	545 €	N	N	HEAA000279	164 €	N	N
CA280/4	HEDA000654	668 €	HEGA000280	426 €	HEGA000652	410 €	HEAA000282	164 €	HEAA000657	164 €
CA310/4	HEDA000655	787 €	HEGA000281	531 €	HEGA000653	391 €	HEAA000283	182 €	HEAA000658	182 €
CA310/6	HEDA000661	728 €	HEGA000287	472 €	HEGA000659	538 €	HEAA000289	182 €	HEAA000664	182 €
CA350/4	HEDA000656	778 €	HEGA000282	493 €	HEGA000654	461 €	HEAA000284	206 €	HEAA000659	206 €
CA350/6	HEDA000662	778 €	HEGA000288	493 €	HEGA000660	658 €	HEAA000290	206 €	HEAA000665	206 €
CA400/4	HEDA000657	956 €	HEGA000283	671 €	HEGA000655	437 €	HEAA000285	253 €	HEAA000660	253 €
CA400/6	HEDA000663	854 €	HEGA000289	568 €	HEGA000661	270 €	HEAA000291	253 €	HEAA000666	253 €
CA450/4	HEDA000658	1,012 €	HEGA000284	686 €	HEGA000656	778 €	HEAA000286	266 €	HEAA000661	266 €
CA450/6	HEDA000664	1,012 €	HEGA000290	686 €	HEGA000662	270 €	HEAA000292	266 €	HEAA000667	266 €
CA500/4	HEDA000659	1,060 €	HEGA000285	941 €	HEGA000657	778 €	HEAA000287	270 €	HEAA000662	270 €
CA500/6	HEDA000665	1,060 €	HEGA000291	707 €	HEGA000663	300 €	HEAA000293	270 €	HEAA000668	270 €
CA560/4	HEDA000660	1,225 €	HEGA000286	1,106 €	HEGA000658	560 €	HEAA000288	367 €	HEAA000663	367 €
CA560/6	HEDA000666	1,225 €	HEGA000292	844 €	HEGA000664	300 €	HEAA000294	367 €	HEAA000669	367 €
CA630/6	HEDA000667	1,288 €	HEGA000293	879 €	HEGA000665	357 €	HEAA000295	400 €	HEAA000670	400 €
CA710/6	N	N	HEGA000294	885 €	N	N	HEAA000296	424 €	N	N
CA800/6	N	N	HEGA000295	991 €	N	N	HEAA000297	514 €	N	N
CA900/8	N	N	HEGA000296	1,102 €	N	N	HEAA000298	561 €	N	N
CA1000/8	N	N	HEGA000297	1,313 €	N	N	HEAA000299	741 €	N	N

RM - Ventilatoren

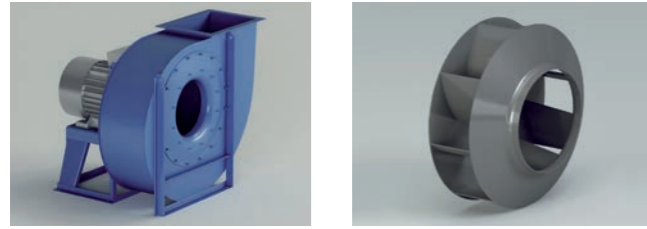

- **Arbeitsbereich :** Niedrige - mittlere - große Fördermengen. Mittlere - niedrige Drücke.
- **Laufrad :** rückwärts gekrümmt, geschlossen.
- **Anwendungen :** Zur Absaugung und zum Transport von stark staubhaltige Luft, vermischt mit Sägestaub, Spänen verschiedener Art, Granulaten, ausser fadenförmigen Materialien.
- **Technische Spezifikationen :** Luftvolumen : 360 bis 180.000 m³/h. Gesamtdruck : 50 bis 560 daPa.

Ventilator	Max-Umdrehungen (rpm)			
	Größe	KLASSE I	KLASSE II	KLASSE III
RM220	5200	6300	-	
RM250/R	5200	6300	-	
RM250	5200	6300	-	
RM280/R	5000	5600	-	
RM280	5000	5600	-	
RM310/R	4800	5200	-	
RM310	4550	5000	-	
RM350/R	4350	4700	-	
RM350	4150	4500	-	
RM400/R	3950	4250	-	
RM400	3750	4000	-	
RM450/R	3550	3800	-	
RM450	3350	3600	-	
RM500/R	3250	3500	-	
RM500	3150	3400	-	
RM560/R	3050	3250	3550	
RM560	3960	3150	3300	
RM630/R	2600	2960	3200	

Ventilator	Max-Umdrehungen (rpm)			
	Größe	KLASSE I	KLASSE II	KLASSE III
RM630	2400	2800	3050	
RM710/R	2250	2700	2950	
RM710	2100	2500	2750	
RM800/R	2000	2400	2600	
RM800	1900	2200	2400	
RM900/R	1750	2100	2300	
RM900	1650	2000	2200	
RM1000/R	1550	1850	2050	
RM1000	1470	1700	1900	
RM1120/R	1350	1600	1750	
RM1120	1250	1485	1650	
RM1250/R	1150	1350	1550	
RM1250	1050	1250	1470	
RM1400/R	1000	1200	1350	
RM1400	950	1150	1300	
RM1600	900	1050	1200	
RM1800	950	1050	1150	

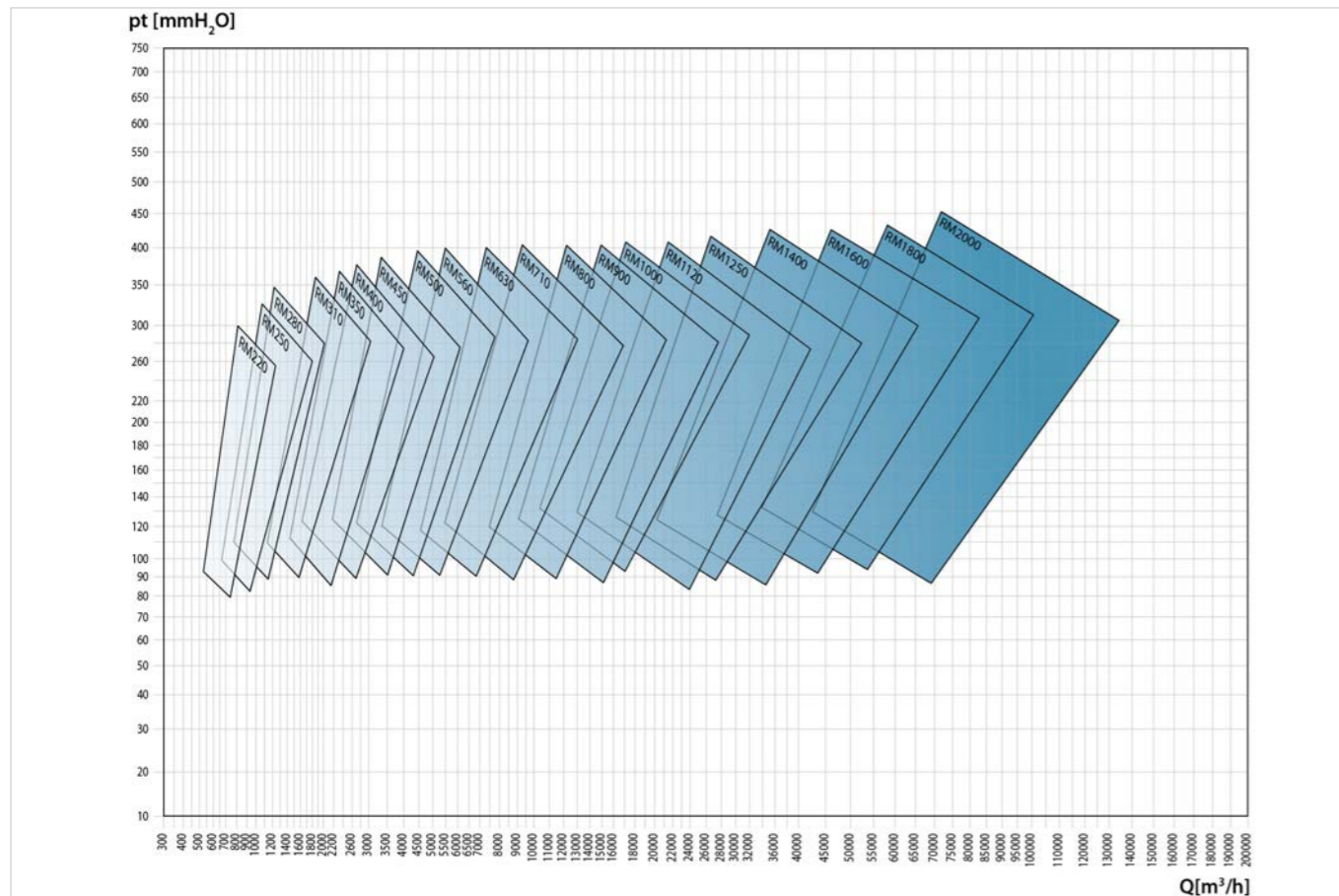

Typ	Gr	kW	Pole	EX4		EX5		ID		HT	
				Code	Preis	Code	Preis	Code	Preis	Code	Preis
RM220/2	63	0,18	2	HBAA000801	286 €	HBAB000047	266 €	HDCA000051	57 €	N	N
RM250/2R	63	0,25	2	HBAA000817	340 €	HBAB000048	312 €	HDCA000052	57 €	N	N
RM250/2	71	0,37	2	HBAA000833	340 €	HBAB000049	312 €	HDCA000053	57 €	HDEA000050	111 €
RM280/2R	71	0,55	2	HBAA000849	402 €	HBAB000050	371 €	HDCA000054	57 €	HDEA000051	111 €
RM280/2	80	0,75	2	HBAA000865	402 €	HBAB000051	371 €	HDCA000055	57 €	HDEA000052	111 €
RM310/2R	80	1,1	2	HBAA000881	451 €	HBAB000052	417 €	HDCA000056	64 €	HDEA000053	111 €
RM310/2	90	1,5	2	HBAA000897	451 €	HBAB000053	417 €	HDCA000057	64 €	HDEA000054	174 €
RM350/2R	90	1,5	2	HBAA000913	571 €	HBAB000054	533 €	HDCA000058	64 €	HDEA000055	174 €
RM350/2	90	2,2	2	HBAA000929	571 €	HBAB000055	533 €	HDCA000059	64 €	HDEA000056	174 €
RM400/2R	100	3	2	HBAA000945	727 €	HBAB000056	682 €	HDCA000060	73 €	HDEA000057	174 €
RM400/2	112	4	2	HBAA000961	727 €	HBAB000057	682 €	HDCA000061	73 €	HDEA000058	174 €
RM450/2R	132	5,5	2	HBAA000977	924 €	HBAB000058	872 €	HDCA000062	73 €	HDEA000059	276 €
RM450/2	132	7,5	2	HBAA000993	924 €	HBAB000059	872 €	HDCA000063	73 €	HDEA000060	276 €
RM500/4R	90	1,1	4	HBAA001073	1,081 €	HBAB000064	1,012 €	HDCA000068	90 €	HDEA000065	174 €
RM500/4	90	1,5	4	HBAA001089	1,081 €	HBAB000065	1,012 €	HDCA000069	90 €	HDEA000066	174 €
RM500/2R	160	11	2	HBAA001009	1,135 €	HBAB000060	1,012 €	HDCA000064	90 €	HDEA000061	276 €
RM500/2	160	15	2	HBAA001025	1,135 €	HBAB000061	1,012 €	HDCA000065	90 €	HDEA000062	276 €
RM560/4R	100	2,2	4	HBAA001105	1,609 €	HBAB000066	1,434 €	HDCA000070	113 €	HDEA000067	174 €
RM560/4	100	3	4	HBAA001121	1,609 €	HBAB000067	1,434 €	HDCA000071	113 €	HDEA000068	174 €
RM560/2R	160	18,5	2	HBAA001041	1,609 €	HBAB000062	1,656 €	HDCA000066	113 €	HDEA000063	276 €
RM560/2	180	22	2	HBAA001057	1,683 €	HBAB000063	1,656 €	HDCA000067	113 €	HDEA000064	276 €
RM630/4R	112	4	4	HBAA001137	2,010 €	HBAB000068	2,065 €	HDCA000072	113 €	HDEA000069	174 €
RM630/4	132	5,5	4	HBAA001153	2,010 €	HBAB000069	2,065 €	HDCA000073	113 €	HDEA000070	276 €
RM710/4R	132	7,5	4	HBAA001169	2,726 €	HBAB000070	2,884 €	HDCA000074	C	HDEA000071	276 €
RM710/4	160	11	4	HBAA001185	2,726 €	HBAB000071	2,884 €	HDCA000075	C	HDEA000072	276 €
RM800/6R	132	4	6	HBAA001329	3,227 €	HBAB000080	3,429 €	HDCA000084	C	HDEA000081	276 €
RM800/6	132	5,5	6	HBAA001345	3,227 €	HBAB000081	3,429 €	HDCA000085	C	HDEA000082	276 €
RM800/4R	160	15	4	HBAA001201	3,227 €	HBAB000072	3,429 €	HDCA000076	C	HDEA000073	276 €
RM800/4	180	18,5	4	HBAA001217	3,227 €	HBAB000073	3,429 €	HDCA000077	C	HDEA000074	276 €
RM900/6R	160	7,5	6	HBAA001361	4,292 €	HBAB000082	4,409 €	HDCA000086	C	HDEA000083	276 €
RM900/6	160	11	6	HBAA001377	4,292 €	HBAB000083	4,409 €	HDCA000087	C	HDEA000084	276 €
RM900/4R	200	30	4	HBAA001233	4,292 €	HBAB000074	4,599 €	HDCA000078	C	HDEA000075	368 €
RM900/4	225	37	4	HBAA001249	4,292 €	HBAB000075	4,599 €	HDCA000079	C	HDEA000076	368 €
RM1000/6R	180	15	6	HBAA001393	5,149 €	HBAB000084	5,323 €	HDCA000088	C	HDEA000085	368 €
RM1000/6	200	18,5	6	HBAA001409	5,149 €	HBAB000085	5,323 €	HDCA000089	C	HDEA000086	368 €
RM1000/4R	225	45	4	HBAA001265	5,149 €	HBAB000076	5,323 €	HDCA000080	C	HDEA000077	368 €
RM1000/4	250	55	4	HBAA001281	5,149 €	HBAB000077	5,323 €	HDCA000081	C	HDEA000078	368 €
RM1120/6R	200	22	6	HBAA001425	6,815 €	HBAB000086	7,069 €	HDCA000090	C	HDEA000087	368 €
RM1120/6	225	30	6	HBAA001441	6,815 €	HBAB000087	7,069 €	HDCA000091	C	HDEA000088	368 €
RM1120/4R	280	75	4	HBAA001297	7,304 €	N	N	HDCA000082	C	HDEA000079	431 €
RM1120/4	280	90	4	HBAA001313	7,304 €	N	N	HDCA000083	C	HDEA000080	431 €
RM1250/6R	250	37	6	HBAA001457	8,739 €	N	N	HDCA000092	C	HDEA000089	368 €
RM1250/6	280	45	6	HBAA001473	9,226 €	N	N	HDCA000093	C	HDEA000090	368 €
RM1400/6R	280	55	6	HBAA001489	10,237 €	N	N	HDCA000094	C	HDEA000091	431 €
RM1400/6	315	75	6	HBAA001505	10,728 €	N	N	HDCA000095	C	HDEA000092	431 €

Typ	TEN		DP		WC		FS		Extra 2GD EX.4	
	Code	Preis	Code	Preis	Code	Preis	Code	Preis	Code	Preis
RM220/2	N	N	HDDA000051	49 €	HDBA000051	99 €	HDAA000051	74 €	N	N
RM250/2R	N	N	HDDA000052	49 €	HDBA000052	112 €	HDAA000052	76 €	N	N
RM250/2	HGBA000050	111 €	HDDA000053	49 €	HDBA000053	112 €	HDAA000053	76 €	HEDA000051	578 €
RM280/2R	HGBA000051	111 €	HDDA000054	49 €	HDBA000054	123 €	HDAA000054	76 €	HEDA000052	622 €
RM280/2	HGBA000052	111 €	HDDA000055	49 €	HDBA000055	123 €	HDAA000055	76 €	HEDA000053	622 €
RM310/2R	HGBA000053	111 €	HDDA000056	49 €	HDBA000056	137 €	HDAA000056	80 €	HEDA000054	661 €
RM310/2	HGBA000054	174 €	HDDA000057	49 €	HDBA000057	137 €	HDAA000057	80 €	HEDA000055	724 €
RM350/2R	HGBA000055	174 €	HDDA000058	49 €	HDBA000058	167 €	HDAA000058	91 €	HEDA000056	778 €
RM350/2	HGBA000056	174 €	HDDA000059	49 €	HDBA000059	167 €	HDAA000059	91 €	HEDA000057	778 €
RM400/2R	HGBA000057	174 €	HDDA000060	49 €	HDBA000060	167 €	HDAA000060	92 €	HEDA000058	854 €
RM400/2	HGBA000058	174 €	HDDA000061	49 €	HDBA000061	167 €	HDAA000061	92 €	HEDA000059	854 €
RM450/2R	HGBA000059	276 €	HDDA000062	49 €	HDBA000062	207 €	HDAA000062	101 €	HEDA000060	1,012 €
RM450/2	HGBA000060	276 €	HDDA000063	49 €	HDBA000063	207 €	HDAA000063	101 €	HEDA000061	1,012 €
RM500/4R	HGBA000065	174 €	HDDA000068	49 €	HDBA000068	234 €	HDAA000068	108 €	HEDA000066	958 €
RM500/4	HGBA000066	174 €	HDDA000069	49 €	HDBA000069	234 €	HDAA000069	108 €	HEDA000067	958 €
RM500/2R	HGBA000061	276 €	HDDA000064	49 €	HDBA000064	234 €	HDAA000064	108 €	HEDA000062	1,060 €
RM500/2	HGBA000062	276 €	HDDA000065	49 €	HDBA000065	234 €	HDAA000065	108 €	HEDA000063	1,060 €
RM560/4R	HGBA000067	174 €	HDDA000070	49 €	HDBA000070	262 €	HDAA000070	C	HEDA000068	1,123 €
RM560/4	HGBA000068	174 €	HDDA000071	49 €	HDBA000071	262 €	HDAA000071	C	HEDA000069	1,123 €
RM560/2R	HGBA000063	276 €	HDDA000066	49 €	HDBA000066	262 €	HDAA000066	C	HEDA000064	1,225 €
RM560/2	HGBA000064	276 €	HDDA000067	49 €	HDBA000067	262 €	HDAA000067	C	HEDA000065	1,225 €
RM630/4R	HGBA000069	174 €	HDDA000072	49 €	HDBA000072	290 €	HDAA000072	C	HEDA000070	1,186 €
RM630/4	HGBA000070	276 €	HDDA000073	49 €	HDBA000073	290 €	HDAA000073	C	HEDA000071	1,288 €
RM710/4R	HGBA000071	276 €	HDDA000074	78 €	HDBA000074	C	HDAA000074	C	HEDA000072	911 €
RM710/4	HGBA000072	276 €	HDDA000075	78 €	HDBA000075	C	HDAA000075	C	HEDA000073	911 €
RM800/6R	HGBA000081	276 €	HDDA000084	78 €	HDBA000084	C	HDAA000084	C	HEDA000082	1,018 €
RM800/6	HGBA000082	276 €	HDDA000085	78 €	HDBA000085	C	HDAA000085	C	HEDA000083	1,018 €
RM800/4R	HGBA000073	276 €	HDDA000076	78 €	HDBA000076	C	HDAA000076	C	HEDA000074	1,018 €
RM800/4	HGBA000074	276 €	HDDA000077	78 €	HDBA000077	C	HDAA000077	C	HEDA000075	1,018 €
RM900/6R	HGBA000083	276 €	HDDA000086	78 €	HDBA000086	C	HDAA000086	C	HEDA000084	1,065 €
RM900/6	HGBA000084	276 €	HDDA000087	78 €	HDBA000087	C	HDAA000087	C	HEDA000085	1,065 €
RM900/4R	HGBA000075	368 €	HDDA000078	78 €	HDBA000078	C	HDAA000078	C	HEDA000076	1,158 €
RM900/4	HGBA000076	368 €	HDDA000079	78 €	HDBA000079	C	HDAA000079	C	HEDA000077	1,158 €
RM1000/6R	HGBA000085	276 €	HDDA000088	78 €	HDBA000088	C	HDAA000088	C	HEDA000086	1,369 €
RM1000/6	HGBA000086	276 €	HDDA000089	78 €	HDBA000089	C	HDAA000089	C	HEDA000087	1,369 €
RM1000/4R	HGBA000077	368 €	HDDA000080	78 €	HDBA000080	C	HDAA000080	C	HEDA000078	1,369 €
RM1000/4	HGBA000078	368 €	HDDA000081	78 €	HDBA000081	C	HDAA000081	C	HEDA000079	1,369 €
RM1120/6R	HGBA000087	368 €	HDDA000090	78 €	HDBA000090	C	HDAA000090	C	HEDA000088	1,765 €
RM1120/6	HGBA000088	368 €	HDDA000091	78 €	HDBA000091	C	HDAA000091	C	HEDA000089	1,765 €
RM1120/4R	HGBA000079	431 €	HDDA000082	78 €	HDBA000082	C	HDAA000082	C	HEDA000080	1,828 €
RM1120/4	HGBA000080	431 €	HDDA000083	78 €	HDBA000083	C	HDAA000083	C	HEDA000081	1,828 €
RM1250/6R	HGBA000089	368 €	HDDA000092	78 €	HDBA000092	C	HDAA000092	C	HEDA000090	1,917 €
RM1250/6	HGBA000090	368 €	HDDA000093	78 €	HDBA000093	C	HDAA000093	C	HEDA000091	1,917 €
RM1400/6R	HGBA000091	431 €	HDDA000094	129 €	HDBA000094	C	HDAA000094	C	HEDA000092	2,491 €
RM1400/6	HGBA000092	431 €	HDDA000095	129 €	HDBA000095	C	HDAA000095	C	HEDA000093	2,491 €

Typ	Extra 2GD EX.5		Extra 3GD EX.4		Extra 3GD EX.5		Extra Tipo C EX.4		Extra Tipo C EX.5	
	Code	Preis	Code	Preis	Code	Preis	Code	Preis	Code	Preis
RM220/2	HEDA000472	435 €	N	N	HEGA000470	217 €	HEAA000050	130 €	HEAA000472	123 €
RM250/2R	HEDA000473	461 €	N	N	HEGA000471	230 €	HEAA000052	141 €	HEAA000473	134 €
RM250/2	HEDA000474	461 €	HEGA000050	347 €	HEGA000472	230 €	HEAA000051	141 €	HEAA000474	134 €
RM280/2R	HEDA000475	503 €	HEGA000051	379 €	HEGA000473	260 €	HEAA000053	164 €	HEAA000475	155 €
RM280/2	HEDA000476	517 €	HEGA000052	379 €	HEGA000474	274 €	HEAA000054	164 €	HEAA000476	169 €
RM310/2R	HEDA000477	556 €	HEGA000053	405 €	HEGA000475	300 €	HEAA000055	182 €	HEAA000477	188 €
RM310/2	HEDA000478	556 €	HEGA000054	468 €	HEGA000476	300 €	HEAA000056	182 €	HEAA000478	188 €
RM350/2R	HEDA000479	608 €	HEGA000055	493 €	HEGA000477	322 €	HEAA000057	206 €	HEAA000479	209 €
RM350/2	HEDA000480	608 €	HEGA000056	493 €	HEGA000478	322 €	HEAA000058	206 €	HEAA000480	209 €
RM400/2R	HEDA000481	692 €	HEGA000057	568 €	HEGA000479	406 €	HEAA000059	253 €	HEAA000481	265 €
RM400/2	HEDA000482	692 €	HEGA000058	568 €	HEGA000480	406 €	HEAA000060	253 €	HEAA000482	265 €
RM450/2R	HEDA000483	766 €	HEGA000059	686 €	HEGA000481	440 €	HEAA000061	266 €	HEAA000483	295 €
RM450/2	HEDA000484	766 €	HEGA000060	686 €	HEGA000482	440 €	HEAA000062	266 €	HEAA000484	295 €
RM500/4R	HEDA000489	759 €	HEGA000065	605 €	HEGA000487	406 €	HEAA000067	270 €	HEAA000489	245 €
RM500/4	HEDA000490	759 €	HEGA000066	605 €	HEGA000488	406 €	HEAA000068	270 €	HEAA000490	245 €
RM500/2R	HEDA000485	837 €	HEGA000061	941 €	HEGA000483	718 €	HEAA000063	270 €	HEAA000485	300 €
RM500/2	HEDA000486	837 €	HEGA000062	941 €	HEGA000484	718 €	HEAA000064	270 €	HEAA000486	300 €
RM560/4R	HEDA000491	951 €	HEGA000067	742 €	HEGA000489	570 €	HEAA000069	367 €	HEAA000491	368 €
RM560/4	HEDA000492	951 €	HEGA000068	742 €	HEGA000490	570 €	HEAA000070	367 €	HEAA000492	368 €
RM560/2R	HEDA000487	951 €	HEGA000063	1,106 €	HEGA000485	832 €	HEAA000065	367 €	HEAA000487	368 €
RM560/2	HEDA000488	951 €	HEGA000064	1,106 €	HEGA000486	832 €	HEAA000066	367 €	HEAA000488	368 €
RM630/4R	HEDA000493	967 €	HEGA000069	777 €	HEGA000491	559 €	HEAA000071	400 €	HEAA000493	356 €
RM630/4	HEDA000494	988 €	HEGA000070	879 €	HEGA000492	580 €	HEAA000072	400 €	HEAA000494	377 €
RM710/4R	HEDA000495	606 €	HEGA000071	792 €	HEGA000493	487 €	HEAA000073	424 €	HEAA000495	395 €
RM710/4	HEDA000496	630 €	HEGA000072	792 €	HEGA000494	511 €	HEAA000074	424 €	HEAA000496	419 €
RM800/6R	HEDA000502	627 €	HEGA000081	899 €	HEGA000500	508 €	HEAA000083	514 €	HEAA000502	399 €
RM800/6	HEDA000503	627 €	HEGA000082	899 €	HEGA000501	508 €	HEAA000084	514 €	HEAA000503	399 €
RM800/4R	HEDA000497	651 €	HEGA000073	899 €	HEGA000495	532 €	HEAA000075	514 €	HEAA000497	423 €
RM800/4	HEDA000498	651 €	HEGA000074	899 €	HEGA000496	532 €	HEAA000076	514 €	HEAA000498	423 €
RM900/6R	HEDA000504	697 €	HEGA000083	946 €	HEGA000502	578 €	HEAA000085	561 €	HEAA000504	469 €
RM900/6	HEDA000505	697 €	HEGA000084	946 €	HEGA000503	578 €	HEAA000086	561 €	HEAA000505	469 €
RM900/4R	HEDA000499	722 €	HEGA000075	1,039 €	HEGA000497	603 €	HEAA000077	561 €	HEAA000499	494 €
RM900/4	HEDA000500	759 €	HEGA000076	1,039 €	HEGA000498	640 €	HEAA000078	561 €	HEAA000500	531 €
RM1000/6R	HEDA000506	774 €	HEGA000085	1,250 €	HEGA000504	634 €	HEAA000087	741 €	HEAA000506	493 €
RM1000/6	HEDA000507	799 €	HEGA000086	1,250 €	HEGA000505	659 €	HEAA000088	741 €	HEAA000507	518 €
RM1000/4R	HEDA000501	815 €	HEGA000077	1,250 €	HEGA000499	696 €	HEAA000079	741 €	HEAA000501	554 €
RM1000/4	N	N	HEGA000078	1,250 €	N	N	HEAA000080	741 €	N	N
RM1120/6R	HEDA000508	833 €	HEGA000087	1,646 €	HEGA000506	693 €	HEAA000089	1,135 €	HEAA000508	550 €
RM1120/6	HEDA000509	869 €	HEGA000088	1,646 €	HEGA000507	729 €	HEAA000090	1,135 €	HEAA000509	587 €
RM1120/4R	N	N	HEGA000079	1,709 €	N	N	HEAA000081	1,135 €	N	N
RM1120/4	N	N	HEGA000080	1,709 €	N	N	HEAA000082	1,135 €	N	N
RM1250/6R	N	N	HEGA000089	1,798 €	N	N	HEAA000091	1,287 €	N	N
RM1250/6	N	N	HEGA000090	1,798 €	N	N	HEAA000092	1,287 €	N	N
RM1400/6R	N	N	HEGA000091	2,372 €	N	N	HEAA000093	1,768 €	N	N
RM1400/6	N	N	HEGA000092	2,372 €	N	N	HEAA000094	1,768 €	N	N

GF - Ventilatoren

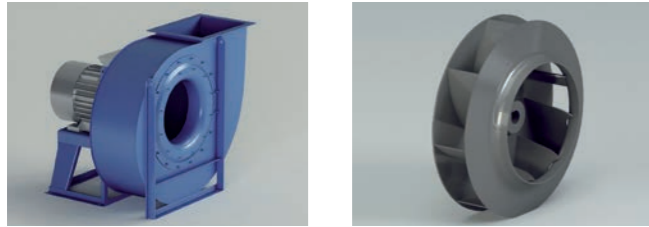

- **Arbeitsbereich :**
Niedrige - mittlere - große Fördermengen. Mittlere Drücke.
- **Laufrad :**
rückwärts gekrümmt, geschlossen.
- **Anwendungen :**
Zur Absaugung und zum Transport von sauberer und staubhaltige Luft, auch mit geringem Anteil von Sägestaub, Spänen verschiedener Art, Granulaten, außer fadenförmigen Materialien.
- **Technische Spezifikationen :**
Luftvolumen : 360 bis 216.000 m³/h.
Gesamtdruck : 70 bis 915 daPa.

Ventilator	Max-Umdrehungen (rpm)				
	Größe	KLASSE I	KLASSE II	KLASSE III	KLASSE IV
GF250	5000	-	-	-	-
GF280	4750	-	-	-	-
GF310	4500	-	-	-	-
GF350	4250	-	-	-	-
GF400	4000	5600	-	-	-
GF450/R	3750	5400	-	-	-
GF450	3600	5000	-	-	-
GF500/R	3500	4750	-	-	-
GF500	3400	4500	5000	-	-
GF560/R	3300	4250	4750	-	-
GF560	3200	4000	4500	-	-
GF630/R	3100	3750	4250	-	-
GF630	2960	3600	4000	-	-
GF710/R	2800	3400	3750	-	-
GF710	2600	3200	3550	-	-

Ventilator	Max-Umdrehungen (rpm)				
	Größe	KLASSE I	KLASSE II	KLASSE III	KLASSE IV
GF800/R	2500	3000	3350	3570	-
GF800	2350	2800	3150	3500	-
GF900/R	2200	2650	3000	3300	-
GF900	2100	2500	2800	3100	-
GF1000/R	2000	2350	2700	-	-
GF1000	1900	2250	2550	-	-
GF1120/R	1800	2150	2400	-	-
GF1120	1700	2000	2250	-	-
GF1250/R	1600	1900	2100	-	-
GF1250	1500	1800	2000	-	-
GF1400/R	1400	1700	1900	-	-
GF1400	1300	1600	1800	-	-
GF1600	1100	1400	1600	-	-
GF1800	1200	1350	1450	-	-

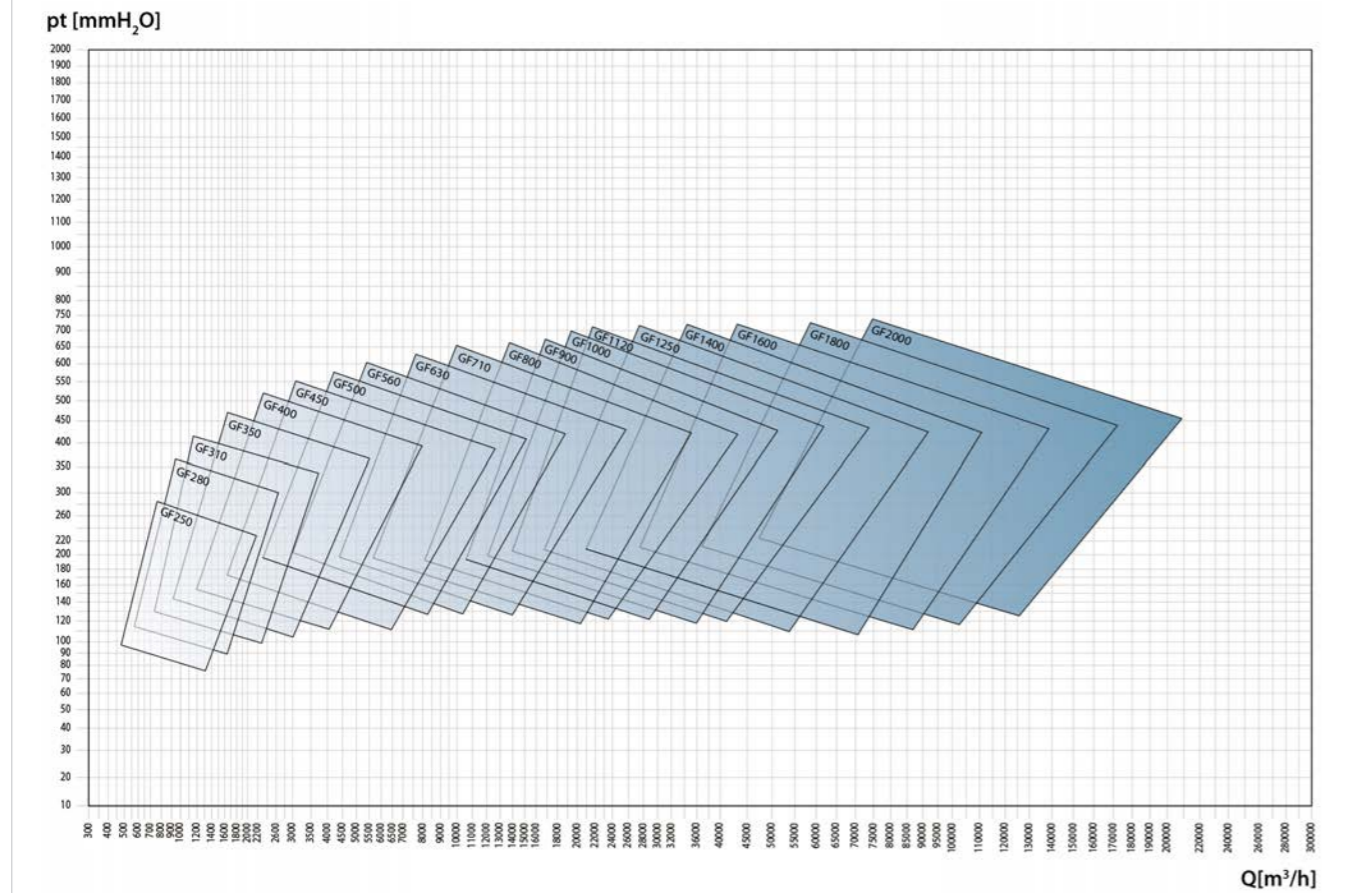

Typ	Gr	kW	Pole	EX4		EX5		ID		HT	
				Code	Preis	Code	Preis	Code	Preis	Code	Preis
GF250/2	71	0,37	2	HBAA001521	361 €	HBAB000088	333 €	HDCA000096	57 €	HDEA000093	111 €
GF280/2	71	0,55	2	HBAA001537	423 €	HBAB000089	392 €	HDCA000097	57 €	HDEA000094	111 €
GF310/2	80	1,1	2	HBAA001553	475 €	HBAB000090	441 €	HDCA000098	64 €	HDEA000095	111 €
GF350/2	90	2,2	2	HBAA001569	605 €	HBAB000091	567 €	HDCA000099	64 €	HDEA000096	174 €
GF400/2	100	3	2	HBAA001585	802 €	HBAB000092	757 €	HDCA000100	73 €	HDEA000097	174 €
GF450/2R	132	5,5	2	HBAA001601	1,023 €	HBAB000093	972 €	HDCA000101	73 €	HDEA000098	276 €
GF450/2	132	5,5	2	HBAA001617	1,023 €	HBAB000094	972 €	HDCA000102	73 €	HDEA000099	276 €
GF500/4	90	1,1	4	HBAA001793	1,198 €	HBAB000103	1,130 €	HDCA000113	90 €	HDEA000110	174 €
GF500/2R	132	7,5	2	HBAA001633	1,253 €	HBAB000095	1,182 €	HDCA000103	90 €	HDEA000100	276 €
GF500/2	132	9,2	2	HBAA001649	1,253 €	HBAB000096	1,182 €	HDCA000104	90 €	HDEA000101	276 €
GF560/4	100	2,2	4	HBAA001809	1,781 €	HBAB000104	1,606 €	HDCA000114	113 €	HDEA000111	174 €
GF560/2R	160	15	2	HBAA001665	1,781 €	HBAB000097	1,828 €	HDCA000105	113 €	HDEA000102	276 €
GF560/2	160	15	2	HBAA001681	1,781 €	HBAB000098	1,828 €	HDCA000106	113 €	HDEA000103	276 €
GF630/4	112	4	4	HBAA001825	2,233 €	HBAB000105	2,288 €	HDCA000115	113 €	HDEA000112	174 €
GF630/2R	180	22	2	HBAA001697	2,334 €	HBAB000099	2,440 €	HDCA000107	113 €	HDEA000104	276 €
GF630/2	200	30	2	HBAA001713	2,334 €	HBAB000100	2,440 €	HDCA000108	113 €	HDEA000105	368 €
GF710/4R	132	5,5	4	HBAA001841	3,011 €	HBAB000106	3,170 €	HDCA000116	C	HDEA000113	276 €
GF710/4	132	7,5	4	HBAA001857	3,011 €	HBAB000107	3,170 €	HDCA000117	C	HDEA000114	276 €
GF710/2R	225	45	2	HBAA001729	3,646 €	HBAB000101	3,732 €	HDCA000109	C	HDEA000106	368 €
GF710/2	250	55	2	HBAA001745	3,646 €	HBAB000102	3,732 €	HDCA000110	C	HDEA000107	368 €
GF800/6	132	4	6	HBAA002065	3,709 €	HBAB000116	3,910 €	HDCA000130	C	HDEA000127	276 €
GF800/4R	160	11	4	HBAA001873	3,709 €	HBAB000108	3,910 €	HDCA000118	C	HDEA000115	276 €
GF800/4	160	15	4	HBAA001889	3,709 €	HBAB000109	3,910 €	HDCA000119	C	HDEA000116	276 €
GF800/2R	280	90	2	HBAA001761	4,571 €	N	N	HDCA000111	C	HDEA000108	431 €
GF800/2	315	110	2	HBAA001777	4,571 €	N	N	HDCA000112	C	HDEA000109	431 €
GF900/6	160	7,5	6	HBAA002081	5,004 €	HBAB000117	5,120 €	HDCA000131	C	HDEA000128	276 €
GF900/4R	180	18,5	4	HBAA001905	5,004 €	HBAB000110	5,120 €	HDCA000120	C	HDEA000117	276 €
GF900/4	200	30	4	HBAA001921	5,004 €	HBAB000111	5,310 €	HDCA000121	C	HDEA000118	368 €
GF1000/6R	160	11	6	HBAA002097	5,915 €	HBAB000118	6,089 €	HDCA000132	C	HDEA000129	276 €
GF1000/6	180	15	6	HBAA002113	5,915 €	HBAB000119	6,089 €	HDCA000133	C	HDEA000130	276 €
GF1000/4R	225	37	4	HBAA001937	5,915 €	HBAB000112	6,089 €	HDCA000122	C	HDEA000119	368 €
GF1000/4	225	45	4	HBAA001953	5,915 €	HBAB000113	6,089 €	HDCA000123	C	HDEA000120	368 €
GF1120/6R	200	18,5	6	HBAA002129	7,847 €	HBAB000120	8,100 €	HDCA000134	C	HDEA000131	368 €
GF1120/6	200	22	6	HBAA002145	7,847 €	HBAB000121	8,100 €	HDCA000135	C	HDEA000132	368 €
GF1120/4R	250	55	4	HBAA001969	7,847 €	HBAB000114	8,100 €	HDCA000124	C	HDEA000121	368 €
GF1120/4	280	75	4	HBAA001985	8,336 €	HBAB000115	8,373 €	HDCA000125	C	HDEA000122	431 €
GF1250/6R	225	30	6	HBAA002161	10,206 €	N	N	HDCA000137	C	HDEA000134	368 €
GF1250/6	250	37	6	HBAA002177	10,206 €	N	N	HDCA000136	C	HDEA000133	368 €
GF1250/4R	315	110	4	HBAA002001	10,693 €	N	N	HDCA000127	C	HDEA000124	431 €
GF1250/4	315	132	4	HBAA002017	10,693 €	N	N	HDCA000126	C	HDEA000123	431 €
GF1400/6R	280	45	6	HBAA002193	12,236 €	N	N	HDCA000139	C	HDEA000136	431 €
GF1400/6	315	75	6	HBAA002209	12,727 €	N	N	HDCA000138	C	HDEA000135	431 €
GF1400/4R	315	200	4	HBAA002033	14,071 €	N	N	HDCA000129	C	HDEA000126	487 €
GF1400/4	315	250	4	HBAA002049	14,071 €	N	N	HDCA000128	C	HDEA000125	487 €
GF1600/6	315	75	6	HBAA002225	22,340 €	N	N	N	N	N	N

Typ	TEN		DP		WC		FS		Extra 2GD EX.4	
	Code	Preis	Code	Preis	Code	Preis	Code	Preis	Code	Preis
GF250/2	HGBA000093	111 €	HDDA000096	49 €	HDBA000096	112 €	HDAA000096	76 €	HEDA000094	578 €
GF280/2	HGBA000094	111 €	HDDA000097	49 €	HDBA000097	123 €	HDAA000097	76 €	HEDA000095	622 €
GF310/2	HGBA000095	111 €	HDDA000098	49 €	HDBA000098	137 €	HDAA000098	80 €	HEDA000096	661 €
GF350/2	HGBA000096	174 €	HDDA000099	49 €	HDBA000099	167 €	HDAA000099	91 €	HEDA000097	778 €
GF400/2	HGBA000097	174 €	HDDA000100	49 €	HDBA000100	167 €	HDAA000100	92 €	HEDA000098	854 €
GF450/2R	HGBA000098	276 €	HDDA000101	49 €	HDBA000101	207 €	HDAA000101	101 €	HEDA000099	1,012 €
GF450/2	HGBA000099	276 €	HDDA000102	49 €	HDBA000102	207 €	HDAA000102	101 €	HEDA000100	1,012 €
GF500/4	HGBA000110	174 €	HDDA000113	49 €	HDBA000113	234 €	HDAA000113	108 €	HEDA000111	974 €
GF500/2R	HGBA000100	276 €	HDDA000103	49 €	HDBA000103	234 €	HDAA000103	108 €	HEDA000101	1,060 €
GF500/2	HGBA000101	276 €	HDDA000104	49 €	HDBA000104	234 €	HDAA000104	108 €	HEDA000102	1,060 €
GF560/4	HGBA000111	174 €	HDDA000114	49 €	HDBA000114	262 €	HDAA000114	C	HEDA000112	1,123 €
GF560/2R	HGBA000102	276 €	HDDA000105	49 €	HDBA000105	262 €	HDAA000105	C	HEDA000103	1,225 €
GF560/2	HGBA000103	276 €	HDDA000106	49 €	HDBA000106	262 €	HDAA000106	C	HEDA000104	1,225 €
GF630/4	HGBA000112	174 €	HDDA000115	49 €	HDBA000115	290 €	HDAA000115	C	HEDA000113	1,186 €
GF630/2R	HGBA000104	276 €	HDDA000107	49 €	HDBA000107	290 €	HDAA000107	C	HEDA000105	1,288 €
GF630/2	HGBA000105	368 €	HDDA000108	49 €	HDBA000108	290 €	HDAA000108	C	HEDA000106	1,380 €
GF710/4R	HGBA000113	276 €	HDDA000116	78 €	HDBA000116	C	HDAA000116	C	HEDA000114	911 €
GF710/4	HGBA000114	276 €	HDDA000117	78 €	HDBA000117	C	HDAA000117	C	HEDA000115	911 €
GF710/2R	HGBA000106	368 €	HDDA000109	78 €	HDBA000109	C	HDAA000109	C	HEDA000107	1,004 €
GF710/2	HGBA000107	368 €	HDDA000110	78 €	HDBA000110	C	HDAA000110	C	HEDA000108	1,004 €
GF800/6	HGBA000128	276 €	HDDA000130	78 €	HDBA000130	C	HDAA000130	C	HEDA000128	1,018 €
GF800/4R	HGBA000115	276 €	HDDA000118	78 €	HDBA000118	C	HDAA000118	C	HEDA000116	1,018 €
GF800/4	HGBA000116	276 €	HDDA000119	78 €	HDBA000119	C	HDAA000119	C	HEDA000117	1,018 €
GF800/2R	HGBA000108	431 €	HDDA000111	78 €	HDBA000111	C	HDAA000111	C	HEDA000109	1,173 €
GF800/2	HGBA000109	431 €	HDDA000112	78 €	HDBA000112	C	HDAA000112	C	HEDA000110	1,173 €
GF900/6	HGBA000129	276 €	HDDA000131	78 €	HDBA000131	C	HDAA000131	C	HEDA000129	1,065 €
GF900/4R	HGBA000117	276 €	HDDA000120	78 €	HDBA000120	C	HDAA000120	C	HEDA000118	1,065 €
GF900/4	HGBA000118	276 €	HDDA000121	78 €	HDBA000121	C	HDAA000121	C	HEDA000119	1,158 €
GF1000/6R	HGBA000130	276 €	HDDA000132	78 €	HDBA000132	C	HDAA000132	C	HEDA000130	1,277 €
GF1000/6	HGBA000131	276 €	HDDA000133	78 €	HDBA000133	C	HDAA000133	C	HEDA000131	1,277 €
GF1000/4R	HGBA000120	368 €	HDDA000122	78 €	HDBA000122	C	HDAA000122	C	HEDA000120	1,369 €
GF1000/4	HGBA000121	368 €	HDDA000123	78 €	HDBA000123	C	HDAA000123	C	HEDA000121	1,369 €
GF1120/6R	HGBA000132	368 €	HDDA000134	78 €	HDBA000134	C	HDAA000134	C	HEDA000132	1,765 €
GF1120/6	HGBA000133	368 €	HDDA000135	78 €	HDBA000135	C	HDAA000135	C	HEDA000133	1,765 €
GF1120/4R	HGBA000122	368 €	HDDA000124	78 €	HDBA000124	C	HDAA000124	C	HEDA000122	1,765 €
GF1120/4	HGBA000123	431 €	HDDA000125	78 €	HDBA000125	C	HDAA000125	C	HEDA000123	1,828 €
GF1250/6R	HGBA000134	368 €	HDDA000137	78 €	HDBA000137	C	HDAA000137	C	HEDA000134	1,917 €
GF1250/6	HGBA000135	368 €	HDDA000136	78 €	HDBA000136	C	HDAA000136	C	HEDA000135	1,917 €
GF1250/4R	HGBA000124	431 €	HDDA000127	78 €	HDBA000127	C	HDAA000127	C	HEDA000124	1,980 €
GF1250/4	HGBA000125	431 €	HDDA000126	78 €	HDBA000126	C	HDAA000126	C	HEDA000125	1,980 €
GF1400/6R	HGBA000136	431 €	HDDA000139	129 €	HDBA000139	C	HDAA000139	C	HEDA000136	2,491 €
GF1400/6	HGBA000137	431 €	HDDA000138	129 €	HDBA000138	C	HDAA000138	C	HEDA000137	2,491 €
GF1400/4R	HGBA000126	487 €	HDDA000129	129 €	HDBA000129	C	HDAA000129	C	HEDA000126	2,547 €
GF1400/4	HGBA000127	487 €	HDDA000128	129 €	HDBA000128	C	HDAA000128	C	HEDA000127	2,547 €
GF1600/6	HGBA000138	487 €	N	N	N	N	N	N	HEDA000138	2,766 €

Typ	Extra 2GD EX.5		Extra 3GD EX.4		Extra 3GD EX.5		Extra Tipo C EX.4		Extra Tipo C EX.5	
	Code	Preis	Code	Preis	Code	Preis	Code	Preis	Code	Preis
GF250/2	HEDA000510	461 €	HEGA000093	347 €	HEGA000508	230 €	HEAA000095	141 €	HEAA000510	134 €
GF280/2	HEDA000511	503 €	HEGA000094	379 €	HEGA000509	260 €	HEAA000096	164 €	HEAA000511	155 €
GF310/2	HEDA000512	556 €	HEGA000095	405 €	HEGA000510	300 €	HEAA000097	182 €	HEAA000512	188 €
GF350/2	HEDA000513	608 €	HEGA000096	493 €	HEGA000511	322 €	HEAA000098	206 €	HEAA000513	209 €
GF400/2	HEDA000514	692 €	HEGA000097	568 €	HEGA000512	406 €	HEAA000099	253 €	HEAA000514	265 €
GF450/2R	HEDA000515	766 €	HEGA000098	686 €	HEGA000513	440 €	HEAA000100	266 €	HEAA000515	295 €
GF450/2	HEDA000516	766 €	HEGA000099	686 €	HEGA000514	440 €	HEAA000101	266 €	HEAA000516	295 €
GF500/4	HEDA000524	759 €	HEGA000110	707 €	HEGA000523	406 €	HEAA000112	270 €	HEAA000525	245 €
GF500/2R	HEDA000517	813 €	HEGA000100	707 €	HEGA000515	461 €	HEAA000102	270 €	HEAA000517	300 €
GF500/2	HEDA000518	813 €	HEGA000101	707 €	HEGA000516	461 €	HEAA000103	270 €	HEAA000518	300 €
GF560/4	HEDA000525	906 €	HEGA000111	844 €	HEGA000524	525 €	HEAA000113	367 €	HEAA000526	323 €
GF560/2R	HEDA000519	951 €	HEGA000102	1,106 €	HEGA000517	832 €	HEAA000104	367 €	HEAA000519	368 €
GF560/2	HEDA000520	951 €	HEGA000103	1,106 €	HEGA000518	832 €	HEAA000105	367 €	HEAA000520	368 €
GF630/4	HEDA000526	967 €	HEGA000112	777 €	HEGA000525	559 €	HEAA000114	400 €	HEAA000527	356 €
GF630/2R	HEDA000521	1,012 €	HEGA000104	1,169 €	HEGA000519	893 €	HEAA000106	400 €	HEAA000521	400 €
GF630/2	HEDA000522	1,037 €	HEGA000105	1,261 €	HEGA000520	918 €	HEAA000107	400 €	HEAA000522	426 €
GF710/4R	HEDA000527	606 €	HEGA000113	792 €	HEGA000526	487 €	HEAA000115	424 €	HEAA000528	395 €
GF710/4	HEDA000528	606 €	HEGA000114	792 €	HEGA000527	487 €	HEAA000116	424 €	HEAA000529	395 €
GF710/2R	HEDA000523	692 €	HEGA000106	885 €	HEGA000521	573 €	HEAA000108	424 €	HEAA000523	480 €
GF710/2	N	N	HEGA000107	885 €	HEGA000522	591 €	HEAA000109	424 €	HEAA000524	480 €
GF800/6	HEDA000535	627 €	HEGA000127	899 €	HEGA000534	508 €	HEAA000129	514 €	HEAA000536	399 €
GF800/4R	HEDA000529	627 €	HEGA000115	899 €	HEGA000528	508 €	HEAA000117	514 €	HEAA000530	399 €
GF800/4	HEDA000530	651 €	HEGA000116	899 €	HEGA000529	532 €	HEAA000118	514 €	HEAA000531	423 €
GF800/2R	N	N	HEGA000108	1,054 €	N	N	HEAA000110	514 €	N	N
GF800/2	N	N	HEGA000109	1,054 €	N	N	HEAA000111	514 €	N	N
GF900/6	HEDA000536	697 €	HEGA000128	946 €	HEGA000535	578 €	HEAA000130	561 €	HEAA000537	469 €
GF900/4R	HEDA000531	697 €	HEGA000117	946 €	HEGA000530	578 €	HEAA000119	561 €	HEAA000532	469 €
GF900/4	HEDA000532	722 €	HEGA000118	1,039 €	HEGA000531	603 €	HEAA000120	561 €	HEAA000533	494 €
GF1000/6R	HEDA000537	774 €	HEGA000129	1,158 €	HEGA000536	634 €	HEAA000131	741 €	HEAA000538	493 €
GF1000/6	HEDA000538	774 €	HEGA000130	1,158 €	HEGA000537	634 €	HEAA000132	741 €	HEAA000539	493 €
GF1000/4R	HEDA000533	836 €	HEGA000119	1,250 €	HEGA000532	696 €	HEAA000121	741 €	HEAA000534	554 €
GF1000/4	HEDA000534	836 €	HEGA000120	1,250 €	HEGA000533	696 €	HEAA000122	741 €	HEAA000535	554 €
GF1120/6R	HEDA000539	833 €	HEGA000131	1,646 €	HEGA000538	693 €	HEAA000133	1,135 €	HEAA000540	550 €
GF1120/6	HEDA000540	833 €	HEGA000132	1,646 €	HEGA000539	693 €	HEAA000134	1,135 €	HEAA000541	550 €
GF1120/4R	N	N	HEGA000121	1,646 €	N	N	HEAA000123	1,135 €	N	N
GF1120/4	N	N	HEGA000122	1,709 €	N	N	HEAA000124	1,135 €	N	N
GF1250/6R	HEDA000541	1,019 €	HEGA000133	1,798 €	HEGA000540	879 €	HEAA000135	1,287 €	HEAA000542	736 €
GF1250/6	N	N	HEGA000134	1,798 €	N	N	HEAA000136	1,287 €	N	N
GF1250/4R	N	N	HEGA000123	1,861 €	N	N	HEAA000125	1,287 €	N	N
GF1250/4	N	N	HEGA000124	1,861 €	N	N	HEAA000126	1,287 €	N	N
GF1400/6R	N	N	HEGA000135	2,372 €	N	N	HEAA000137	1,768 €	N	N
GF1400/6	N	N	HEGA000136	2,372 €	N	N	HEAA000138	1,768 €	N	N
GF1400/4R	N	N	HEGA000125	2,428 €	N	N	HEAA000127	1,768 €	N	N
GF1400/4	N	N	HEGA000126	2,428 €	N	N	HEAA000128	1,768 €	N	N
GF1600/6	N	N	HEGA000137	2,647 €	N	N	HEAA000139	1,988 €	N	N

GR - Ventilatoren

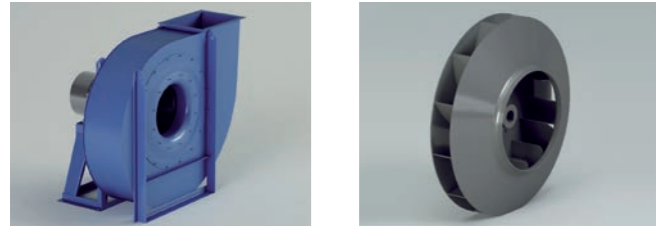

- **Arbeitsbereich:** Niedrige - mittlere - große Fördermengen. Mittlere Drücke.
- **Laufrad:** rückwärts gekrümmt, geschlossen.
- **Anwendungen:** Zum Transport von Luft, Rauch, Feinstaub. Zum Transport von in Luft enthaltenen Feststoffen, Spänen und Sägestaub bei nicht direkt durchströmten Ventilator geeignet.
- **Technische Spezifikationen:** Luftvolumen : 1.500 bis 140.000 m³/h. Gesamtdruck : 150 bis 1.100 daPa.

Ventilator	Max-Umdrehungen (rpm)			
	Größe	KLASSE I	KLASSE II	KLASSE III
GR400/R	4100	5800	-	-
GR400	4000	5600	-	-
GR450/R	3750	5400	-	-
GR450	3600	5000	-	-
GR500/R	3500	4750	-	-
GR500	3400	4500	4750	-
GR560/R	3300	4250	4500	-
GR560	3200	4000	4250	-
GR630/R	3100	3750	4000	-
GR630	2970	3600	3750	-
GR710/R	2800	3400	3550	-
GR710	2600	3200	3350	-
GR800/R	2500	3000	3350	3570

Ventilator	Max-Umdrehungen (rpm)			
	Größe	KLASSE I	KLASSE II	KLASSE III
GR800	2350	2800	3150	3500
GR900/R	2200	2650	3000	3300
GR900	2100	2500	2800	3100
GR1000/R	2000	2350	2700	-
GR1000	1900	2250	2550	-
GR1120/R	1800	2150	2400	-
GR1120	1700	2000	2250	-
GR1250/R	1600	1900	2100	-
GR1250	1500	1800	2000	-
GR1400/R	1400	1700	1900	-
GR1400	1300	1600	1800	-
GR1600	1100	1400	1600	-
GR1800	1200	1350	1460	-

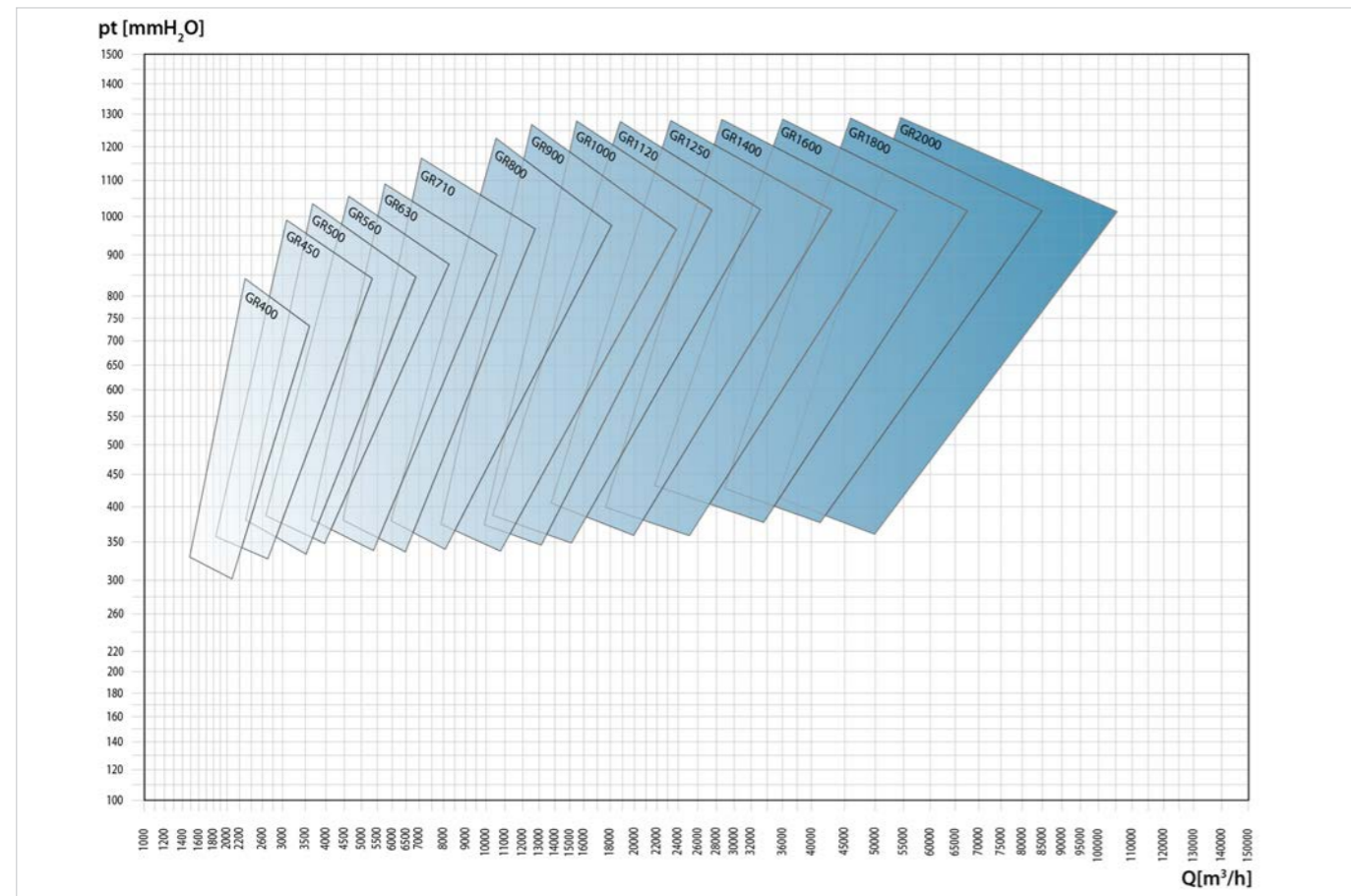

Typ	Gr	kW	Pole	EX4		EX5		ID		HT	
				Code	Preis	Code	Preis	Code	Preis	Code	Preis
GR400/2R	90	2,2	2	HBAA002745	819 €	HBAB000150	774 €	HDCA000173	73 €	HDEA000171	174 €
GR400/2	100	3	2	HBAA002729	819 €	HBAB000149	774 €	HDCA000172	73 €	HDEA000170	174 €
GR450/2R	112	4	2	HBAA002777	1,008 €	HBAB000152	956 €	HDCA000175	73 €	HDEA000173	174 €
GR450/2	132	5,5	2	HBAA002761	1,008 €	HBAB000151	956 €	HDCA000174	73 €	HDEA000172	276 €
GR500/2R	132	7,5	2	HBAA002809	1,183 €	HBAB000154	1,114 €	HDCA000177	90 €	HDEA000175	276 €
GR500/2	160	11	2	HBAA002793	1,238 €	HBAB000153	1,114 €	HDCA000176	90 €	HDEA000174	276 €
GR560/4R	90	1,5	4	HBAA003001	1,641 €	HBAB000162	1,466 €	HDCA000189	113 €	HDEA000187	174 €
GR560/4	100	2,2	4	HBAA002985	1,641 €	HBAB000161	1,466 €	HDCA000188	113 €	HDEA000186	174 €
GR560/2R	160	11	2	HBAA002841	1,641 €	HBAB000156	1,688 €	HDCA000179	113 €	HDEA000177	276 €
GR560/2	160	15	2	HBAA002825	1,641 €	HBAB000155	1,688 €	HDCA000178	113 €	HDEA000176	276 €
GR630/4R	100	3	4	HBAA003033	2,260 €	HBAB000164	2,314 €	HDCA000191	113 €	HDEA000189	174 €
GR630/4	112	4	4	HBAA003017	2,260 €	HBAB000163	2,314 €	HDCA000190	113 €	HDEA000188	174 €
GR630/2R	180	22	2	HBAA002873	2,360 €	HBAB000158	2,314 €	HDCA000181	113 €	HDEA000179	276 €
GR630/2	200	30	2	HBAA002857	2,360 €	HBAB000157	2,467 €	HDCA000180	113 €	HDEA000178	368 €
GR710/4R	112	4	4	HBAA003065	2,940 €	HBAB000166	3,098 €	HDCA000193	C	HDEA000191	174 €
GR710/4	132	5,5	4	HBAA003049	2,940 €	HBAB000165	3,098 €	HDCA000192	C	HDEA000190	276 €
GR710/2R	200	37	2	HBAA002905	3,574 €	HBAB000160	3,661 €	HDCA000183	C	HDEA000181	368 €
GR710/2	225	45	2	HBAA002889	3,574 €	HBAB000159	3,661 €	HDCA000182	C	HDEA000180	368 €
GR800/4R	132	7,5	4	HBAA003097	3,602 €	HBAB000168	3,804 €	HDCA000195	C	HDEA000193	276 €
GR800/4	160	11	4	HBAA003081	3,602 €	HBAB000167	3,804 €	HDCA000194	C	HDEA000192	276 €
GR800/2R	280	75	2	HBAA002937	4,465 €	N	N	HDCA000185	C	HDEA000183	431 €
GR800/2	280	90	2	HBAA002921	4,465 €	N	N	HDCA000184	C	HDEA000182	431 €
GR900/6R	132	4	6	HBAA003289	4,676 €	HBAB000176	4,792 €	HDCA000205	C	HDEA000203	276 €
GR900/6	132	5,5	6	HBAA003273	4,676 €	HBAB000175	4,792 €	HDCA000204	C	HDEA000202	276 €
GR900/4R	160	15	4	HBAA003129	4,676 €	HBAB000170	4,792 €	HDCA000197	C	HDEA000195	276 €
GR900/4	180	22	4	HBAA003113	4,676 €	HBAB000169	4,792 €	HDCA000196	C	HDEA000194	276 €
GR900/2R	315	132	2	HBAA002969	5,649 €	N	N	HDCA000187	C	HDEA000185	431 €
GR900/2	315	160	2	HBAA002953	5,649 €	N	N	HDCA000186	C	HDEA000184	431 €
GR1000/6R	160	7,5	6	HBAA003321	5,424 €	HBAB000178	5,597 €	HDCA000207	C	HDEA000205	276 €
GR1000/6	160	11	6	HBAA003305	5,424 €	HBAB000177	5,597 €	HDCA000206	C	HDEA000204	276 €
GR1000/4R	200	30	4	HBAA003161	5,424 €	HBAB000172	5,597 €	HDCA000199	C	HDEA000197	368 €
GR1000/4	225	37	4	HBAA003145	5,424 €	HBAB000171	5,597 €	HDCA000198	C	HDEA000196	368 €
GR1120/6R	180	15	6	HBAA003353	7,267 €	HBAB000180	7,521 €	HDCA000209	C	HDEA000207	276 €
GR1120/6	200	18,5	6	HBAA003337	7,267 €	HBAB000179	7,521 €	HDCA000208	C	HDEA000206	368 €
GR1120/4R	225	45	4	HBAA003193	7,267 €	HBAB000174	7,521 €	HDCA000201	C	HDEA000199	368 €
GR1120/4	250	55	4	HBAA003177	7,267 €	HBAB000173	7,521 €	HDCA000200	C	HDEA000198	368 €
GR1250/6R	200	22	6	HBAA003385	9,751 €	N	N	HDCA000211	C	HDEA000209	368 €
GR1250/6	225	30	6	HBAA003369	9,751 €	N	N	HDCA000210	C	HDEA000208	368 €
GR1250/4R	280	75	4	HBAA003225	10,238 €	N	N	HDCA000203	C	HDEA000201	431 €
GR1250/4	315	110	4	HBAA003209	10,238 €	N	N	HDCA000202	C	HDEA000200	431 €
GR1400/6R	250	37	6	HBAA003417	11,822 €	N	N	HDCA000213	C	HDEA000211	368 €
GR1400/6	280	55	6	HBAA003401	11,822 €	N	N	HDCA000212	C	HDEA000210	431 €
GR1400/4R	315	132	4	HBAA003257	13,657 €	N	N	N	N	N	N
GR1400/4	315	160	4	HBAA003241	13,657 €	N	N	N	N	N	N

Typ	TEN		DP		WC		FS		Extra 2GD EX.4	
	Code	Preis	Code	Preis	Code	Preis	Code	Preis	Code	Preis
GR400/2R	HGBA000171	174 €	HDDA000173	49 €	HDBA000173	167 €	HDAA000173	92 €	HEDA000171	854 €
GR400/2	HGBA000170	174 €	HDDA000172	49 €	HDBA000172	167 €	HDAA000172	92 €	HEDA000170	854 €
GR450/2R	HGBA000173	174 €	HDDA000175	49 €	HDBA000175	207 €	HDAA000175	101 €	HEDA000173	910 €
GR450/2	HGBA000172	276 €	HDDA000174	49 €	HDBA000174	207 €	HDAA000174	101 €	HEDA000172	1,012 €
GR500/2R	HGBA000175	276 €	HDDA000177	49 €	HDBA000177	204 €	HDAA000177	108 €	HEDA000175	1,060 €
GR500/2	HGBA000174	276 €	HDDA000176	49 €	HDBA000176	204 €	HDAA000176	108 €	HEDA000174	1,060 €
GR560/4R	HGBA000187	174 €	HDDA000189	49 €	HDBA000189	262 €	HDAA000187	C	HEDA000187	1,123 €
GR560/4	HGBA000186	174 €	HDDA000188	49 €	HDBA000188	262 €	HDAA000186	C	HEDA000186	1,123 €
GR560/2R	HGBA000177	276 €	HDDA000179	49 €	HDBA000179	262 €	HDAA000179	C	HEDA000177	1,225 €
GR560/2	HGBA000176	276 €	HDDA000178	49 €	HDBA000178	262 €	HDAA000178	C	HEDA000176	1,225 €
GR630/4R	HGBA000189	174 €	HDDA000191	49 €	HDBA000191	290 €	HDAA000189	C	HEDA000189	1,186 €
GR630/4	HGBA000188	174 €	HDDA000190	49 €	HDBA000190	290 €	HDAA000188	C	HEDA000188	1,186 €
GR630/2R	HGBA000179	276 €	HDDA000181	49 €	HDBA000181	262 €	HDAA000181	C	HEDA000179	1,288 €
GR630/2	HGBA000178	368 €	HDDA000180	49 €	HDBA000180	290 €	HDAA000180	C	HEDA000178	1,380 €
GR710/4R	HGBA000191	174 €	HDDA000193	78 €	HDBA000193	C	HDAA000191	C	HEDA000191	809 €
GR710/4	HGBA000190	276 €	HDDA000192	78 €	HDBA000192	C	HDAA000190	C	HEDA000190	911 €
GR710/2R	HGBA000181	368 €	HDDA000183	78 €	HDBA000183	C	HDAA000183	C	HEDA000181	1,004 €
GR710/2	HGBA000180	368 €	HDDA000182	78 €	HDBA000182	C	HDAA000182	C	HEDA000180	1,004 €
GR800/4R	HGBA000193	276 €	HDDA000195	78 €	HDBA000195	C	HDAA000193	C	HEDA000193	1,018 €
GR800/4	HGBA000192	276 €	HDDA000194	78 €	HDBA000194	C	HDAA000192	C	HEDA000192	1,018 €
GR800/2R	HGBA000183	431 €	HDDA000185	78 €	HDBA000185	C	HDAA000184	C	HEDA000183	1,173 €
GR800/2	HGBA000182	431 €	HDDA000184	78 €	HDBA000184	C	HDAA000185	C	HEDA000182	1,173 €
GR900/6R	HGBA000205	276 €	HDDA000205	78 €	HDBA000205	C	HDAA000203	C	HEDA000205	1,065 €
GR900/6	HGBA000204	276 €	HDDA000204	78 €	HDBA000204	C	HDAA000202	C	HEDA000204	1,065 €
GR900/4R	HGBA000195	276 €	HDDA000197	78 €	HDBA000197	C	HDAA000195	C	HEDA000195	1,065 €
GR900/4	HGBA000194	276 €	HDDA000196	78 €	HDBA000196	C	HDAA000194	C	HEDA000194	1,065 €
GR900/2R	HGBA000185	431 €	HDDA000187	78 €	HDBA000187	C		C	HEDA000185	1,221 €
GR900/2	HGBA000184	431 €	HDDA000186	78 €	HDBA000186	C		C	HEDA000184	1,221 €
GR1000/6R	HGBA000207	276 €	HDDA000207	78 €	HDBA000207	C	HDAA000205	C	HEDA000207	1,277 €
GR1000/6	HGBA000206	276 €	HDDA000206	78 €	HDBA000206	C	HDAA000204	C	HEDA000206	1,277 €
GR1000/4R	HGBA000197	368 €	HDDA000199	78 €	HDBA000199	C	HDAA000197	C	HEDA000197	1,369 €
GR1000/4	HGBA000196	368 €	HDDA000198	78 €	HDBA000198	C	HDAA000196	C	HEDA000196	1,369 €
GR1120/6R	HGBA000209	276 €	HDDA000209	78 €	HDBA000209	C	HDAA000207	C	HEDA000209	1,673 €
GR1120/6	HGBA000208	368 €	HDDA000208	78 €	HDBA000208	C	HDAA000206	C	HEDA000208	1,765 €
GR1120/4R	HGBA000199	368 €	HDDA000201	78 €	HDBA000201	C	HDAA000199	C	HEDA000199	1,765 €
GR1120/4	HGBA000198	368 €	HDDA000200	78 €	HDBA000200	C	HDAA000198	C	HEDA000198	1,765 €
GR1250/6R	HGBA000211	368 €	HDDA000211	78 €	HDBA000211	C	HDAA000209	C	HEDA000211	1,917 €
GR1250/6	HGBA000210	368 €	HDDA000210	78 €	HDBA000210	C	HDAA000208	C	HEDA000210	1,917 €
GR1250/4R	HGBA000201	431 €	HDDA000203	78 €	HDBA000203	C	HDAA000201	C	HEDA000201	1,980 €
GR1250/4	HGBA000200	431 €	HDDA000202	78 €	HDBA000202	C	HDAA000200	C	HEDA000200	1,980 €
GR1400/6R	HGBA000213	368 €	HDDA000213	129 €	HDBA000213	C	HDAA000211	C	HEDA000213	2,428 €
GR1400/6	HGBA000212	431 €	HDDA000212	129 €	HDBA000212	C	HDAA000210	C	HEDA000212	2,491 €
GR1400/4R	HGBA000203	487 €	N	N	N	N	N	N	HEDA000203	2,547 €
GR1400/4	HGBA000202	487 €	N	N	N	N	N	N	HEDA000202	2,547 €

Typ	Extra 2GD EX.5		Extra 3GD EX.4		Extra 3GD EX.5		Extra Tipo C EX.4		Extra Tipo C EX.5	
	Code	Preis	Code	Preis	Code	Preis	Code	Preis	Code	Preis
GR400/2R	HEDA000564	585 €	HEGA000170	568 €	HEGA000563	419 €	HEAA000172	253 €	HEAA000565	231 €
GR400/2	HEDA000563	619 €	HEGA000169	568 €	HEGA000562	419 €	HEAA000171	253 €	HEAA000564	265 €
GR450/2R	HEDA000566	672 €	HEGA000172	584 €	HEGA000565	718 €	HEAA000174	266 €	HEAA000567	274 €
GR450/2	HEDA000565	693 €	HEGA000171	686 €	HEGA000564	718 €	HEAA000173	266 €	HEAA000566	295 €
GR500/2R	HEDA000568	724 €	HEGA000174	707 €	HEGA000567	832 €	HEAA000176	270 €	HEAA000569	300 €
GR500/2	HEDA000567	748 €	HEGA000173	941 €	HEGA000566	832 €	HEAA000175	270 €	HEAA000568	323 €
GR560/4R	HEDA000576	759 €	HEGA000186	844 €	HEGA000575	281 €	HEAA000188	367 €	HEAA000577	290 €
GR560/4	HEDA000575	792 €	HEGA000185	844 €	HEGA000574	281 €	HEAA000187	367 €	HEAA000576	323 €
GR560/2R	HEDA000570	837 €	HEGA000176	1,106 €	HEGA000569	918 €	HEAA000178	367 €	HEAA000571	368 €
GR560/2	HEDA000569	837 €	HEGA000175	1,106 €	HEGA000568	918 €	HEAA000177	367 €	HEAA000570	368 €
GR630/4R	HEDA000578	854 €	HEGA000188	879 €	HEGA000577	319 €	HEAA000190	400 €	HEAA000579	356 €
GR630/4	HEDA000577	854 €	HEGA000187	879 €	HEGA000576	351 €	HEAA000189	400 €	HEAA000578	356 €
GR630/2R	HEDA000572	899 €	HEGA000178	1,169 €	HEGA000571	525 €	HEAA000180	367 €	HEAA000573	400 €
GR630/2	HEDA000571	924 €	HEGA000177	1,261 €	HEGA000570	777 €	HEAA000179	400 €	HEAA000572	426 €
GR710/4R	HEDA000580	585 €	HEGA000190	690 €	HEGA000579	395 €	HEAA000192	424 €	HEAA000581	374 €
GR710/4	HEDA000579	606 €	HEGA000189	792 €	HEGA000578	414 €	HEAA000191	424 €	HEAA000580	395 €
GR710/2R	HEDA000574	655 €	HEGA000180	885 €	HEGA000573	272 €	HEAA000182	424 €	HEAA000575	444 €
GR710/2	HEDA000573	692 €	HEGA000179	885 €	HEGA000572	259 €	HEAA000181	424 €	HEAA000574	480 €
GR800/4R	HEDA000582	627 €	HEGA000192	899 €	HEGA000581	440 €	HEAA000194	514 €	HEAA000583	399 €
GR800/4	HEDA000581	651 €	HEGA000191	899 €	HEGA000580	463 €	HEAA000193	514 €	HEAA000582	423 €
GR800/2R	N	N	HEGA000182	1,054 €	N	N	HEAA000184	514 €	N	N
GR800/2	N	N	HEGA000181	1,054 €	N	N	HEAA000183	514 €	N	N
GR900/6R	HEDA000588	697 €	HEGA000204	946 €	HEGA000587	650 €	HEAA000206	561 €	HEAA000589	469 €
GR900/6	N	N	HEGA000203	946 €	N	N	HEAA000205	561 €	N	N
GR900/4R	HEDA000584	697 €	HEGA000194	946 €	HEGA000583	512 €	HEAA000196	561 €	HEAA000585	469 €
GR900/4	HEDA000583	697 €	HEGA000193	946 €	HEGA000582	512 €	HEAA000195	561 €	HEAA000584	469 €
GR900/2R	N	N	HEGA000184	1,102 €	N	N	HEAA000186	561 €	N	N
GR900/2	N	N	HEGA000183	1,102 €	N	N	HEAA000185	561 €	N	N
GR1000/6R	HEDA000590	774 €	HEGA000206	1,158 €	HEGA000589	230 €	HEAA000208	741 €	HEAA000591	493 €
GR1000/6	HEDA000589	774 €	HEGA000205	1,158 €	HEGA000588	216 €	HEAA000207	741 €	HEAA000590	493 €
GR1000/4R	HEDA000586	799 €	HEGA000196	1,250 €	HEGA000585	529 €	HEAA000198	741 €	HEAA000587	518 €
GR1000/4	HEDA000585	836 €	HEGA000195	1,250 €	HEGA000584	552 €	HEAA000197	741 €	HEAA000586	554 €
GR1120/6R	HEDA000592	808 €	HEGA000208	1,554 €	HEGA000591	277 €	HEAA000210	1,135 €	HEAA000593	525 €
GR1120/6	HEDA000591	833 €	HEGA000207	1,646 €	HEGA000590	231 €	HEAA000209	1,135 €	HEAA000592	550 €
GR1120/4R	HEDA000587	848 €	HEGA000198	1,646 €	HEGA000586	650 €	HEAA000200	1,135 €	HEAA000588	587 €
GR1120/4	N	N	HEGA000197	1,646 €	N	N	HEAA000199	1,135 €	N	N
GR1250/6R	HEDA000594	983 €	HEGA000210	1,798 €	HEGA000593	230 €	HEAA000212	1,287 €	HEAA000595	700 €
GR1250/6	HEDA000593	1,019 €	HEGA000209	1,798 €	HEGA000592	217 €	HEAA000211	1,287 €	HEAA000594	736 €
GR1250/4R	N	N	HEGA000200	1,861 €	N	N	HEAA000202	1,287 €	N	N
GR1250/4	N	N	HEGA000199	1,861 €	N	N	HEAA000201	1,287 €	N	N
GR1400/6R	N	N	HEGA000212	2,309 €	N	N	HEAA000214	1,768 €	N	N
GR1400/6	N	N	HEGA000211	2,372 €	N	N	HEAA000213	1,768 €	N	N
GR1400/4R	N	N	HEGA000202	2,428 €	N	N	HEAA000204	1,768 €	N	N
GR1400/4	N	N	HEGA000201	2,428 €	N	N	HEAA000203	1,768 €	N	N

RH - Ventilatoren

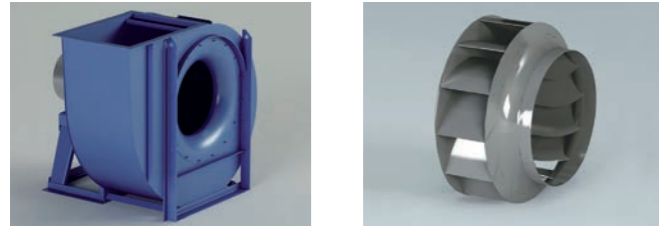

- **Arbeitsbereich :** Mittlere - große Fördermengen.
- **Laufrad :** rückwärts gekrümmt, geschlossen.
- **Anwendungen :** Zur Absaugung und zum Transport von sauberer und staubhaltiger Luft.
- **Technische Spezifikationen :** Luftvolumen : 1.800 bis 288.000 m³/h. Gesamtdruck : 60 bis 530 daPa.

Ventilator	Max-Umdrehungen (rpm)			
	Größe	KLASSE I	KLASSE II	KLASSE III
RH400	3450	3900	4500	-
RH450/R	3150	3600	4250	-
RH450	3050	3500	4000	-
RH500/R	2900	3300	3850	-
RH500	2750	3150	3700	-
RH560/R	2550	2900	3550	-
RH560	2450	2800	3400	-
RH630/R	2300	2600	3200	-
RH630	2200	2500	3000	-
RH710/R	2350	2800	3100	3550
RH710	2200	2650	2960	3350
RH800/R	2050	2500	2750	3150
RH800	1950	2350	2600	2960

Ventilator	Max-Umdrehungen (rpm)			
	Größe	KLASSE I	KLASSE II	KLASSE III
RH900/R	1800	2200	2400	2750
RH900	1750	2050	2250	2550
RH1000/R	1600	1950	2100	-
RH1000	1550	1850	2000	-
RH1120/R	1700	1850	2000	-
RH1120	1600	1750	1900	-
RH1250/R	1500	1650	1800	-
RH1250	1400	1550	1700	-
RH1400/R	1300	1450	1600	-
RH1400	1200	1350	1500	-
RH1600	1000	1150	1300	-
RH1800	850	1000	1150	-

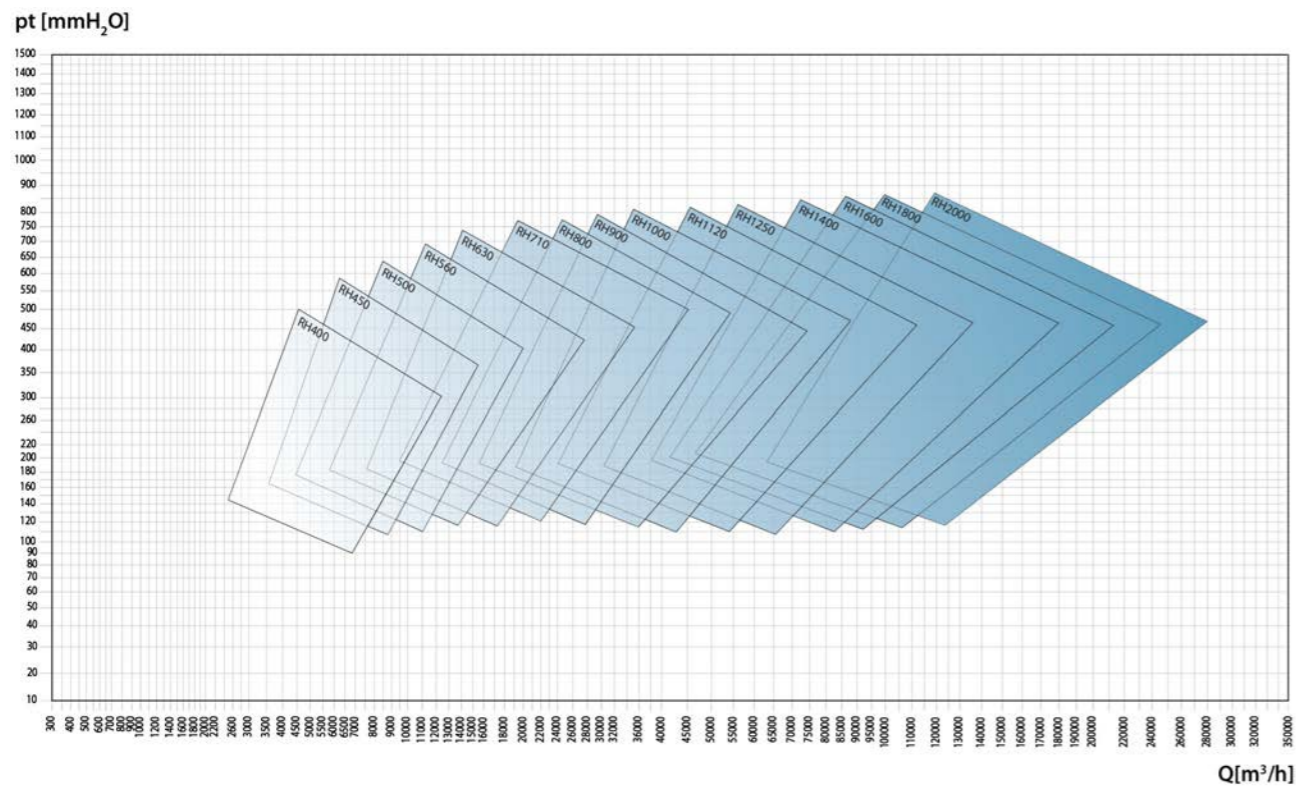

Typ	Gr	kW	Pole	EX4		EX5		ID		HT	
				Code	Preis	Code	Preis	Code	Preis	Code	Preis
RH400/2	112	4	2	HBAA003433	980 €	HBAB000181	935 €	HDCA000214	73 €	HDEA000212	276 €
RH450/2R	132	7,5	2	HBAA003465	1,166 €	HBAB000184	1,114 €	HDCA000216	73 €	HDEA000215	276 €
RH450/2	132	7,5	2	HBAA003449	1,166 €	HBAB000182	1,114 €	HDCA000215	73 €	HDEA000214	276 €
RH500/2R	160	11	2	HBAA003497	1,793 €	HBAB000186	1,778 €	HDCA000218	90 €	HDEA000217	276 €
RH500/2	160	15	2	HBAA003481	1,793 €	HBAB000185	1,778 €	HDCA000217	90 €	HDEA000216	276 €
RH560/2R	160	18,5	2	HBAA003529	2,048 €	HBAB000189	2,131 €	HDCA000221	113 €	HDEA000220	276 €
RH560/2	180	22	2	HBAA003513	2,048 €	HBAB000187	2,131 €	HDCA000219	113 €	HDEA000218	368 €
RH630/4R	112	4	4	HBAA003593	2,332 €	HBAB000195	2,387 €	HDCA000225	113 €	HDEA000224	174 €
RH630/4	132	5,5	4	HBAA003577	2,332 €	HBAB000194	2,387 €	HDCA000224	113 €	HDEA000223	174 €
RH630/2R	200	30	2	HBAA003561	2,723 €	HBAB000191	2,876 €	HDCA000223	113 €	HDEA000222	368 €
RH630/2	200	37	2	HBAA003545	2,723 €	HBAB000190	2,876 €	HDCA000222	113 €	HDEA000221	368 €

Typ	TEN		DP		WC		FS		Extra 2GD EX.4	
	Code	Preis	Code	Preis	Code	Preis	Code	Preis	Code	Preis
RH400/2	HGBA000214	174 €	HDDA000214	49 €	HDBA000214	167 €	HDAA000212	92 €	HEDA000214	854 €
RH450/2R	HGBA000217	276 €	HDDA000216	49 €	HDBA000216	207 €	HDAA000214	101 €	HEDA000216	1,012 €
RH450/2	HGBA000216	276 €	HDDA000215	49 €	HDBA000215	207 €	HDAA000213	101 €	HEDA000215	1,012 €
RH500/2R	HGBA000219	276 €	HDDA000218	49 €	HDBA000218	234 €	HDAA000216	C	HEDA000218	1,060 €
RH500/2	HGBA000218	276 €	HDDA000217	49 €	HDBA000217	234 €	HDAA000215	C	HEDA000217	1,060 €
RH560/2R	HGBA000222	276 €	HDDA000221	49 €	HDBA000221	262 €	HDAA000219	C	HEDA000220	1,225 €
RH560/2	HGBA000220	276 €	HDDA000219	49 €	HDBA000219	262 €	HDAA000217	C	HEDA000219	1,225 €
RH630/4R	HGBA000226	174 €	HDDA000225	49 €	HDBA000225	290 €	HDAA000223	C	HEDA000224	1,186 €
RH630/4	HGBA000225	174 €	HDDA000224	49 €	HDBA000224	290 €	HDAA000222	C	HEDA000223	119 €
RH630/2R	HGBA000224	368 €	HDDA000223	49 €	HDBA000223	290 €	HDAA000221	C	HEDA000222	1,380 €
RH630/2	HGBA000223	368 €	HDDA000222	49 €	HDBA000222	290 €	HDAA000220	C	HEDA000221	1,380 €

Typ	Extra 2GD EX.5		Extra 3GD EX.4		Extra 3GD EX.5		Extra Tipo C EX.4		Extra Tipo C EX.5	
	Code	Preis	Code	Preis	Code	Preis	Code	Preis	Code	Preis
RH400/2	HEDA000595	658 €	HEGA000213	568 €	HEGA000594	274 €	HEAA000215	253 €	HEAA000596	231 €
RH450/2R	HEDA000597	745 €	HEGA000215	686 €	HEGA000596	356 €	HEAA000217	266 €	HEAA000598	274 €
RH450/2	HEDA000596	745 €	HEGA000214	686 €	HEGA000595	300 €	HEAA000216	266 €	HEAA000597	274 €
RH500/2R	HEDA000599	837 €	HEGA000217	941 €	HEGA000598	440 €	HEAA000219	270 €	HEAA000600	323 €
RH500/2	HEDA000598	837 €	HEGA000216	941 €	HEGA000597	427 €	HEAA000218	270 €	HEAA000599	323 €
RH560/2R	HEDA000601	951 €	HEGA000219	1,106 €	HEGA000600	832 €	HEAA000221	367 €	HEAA000602	368 €
RH560/2	HEDA000600	951 €	HEGA000218	1,106 €	HEGA000599	718 €	HEAA000220	367 €	HEAA000601	368 €
RH630/4R	HEDA000605	934 €	HEGA000223	777 €	HEGA000604	440 €	HEAA000225	400 €	HEAA000606	322 €
RH630/4	HEDA000604	120 €	HEGA000222	848 €	HEGA000603	406 €	HEAA000224	559 €	HEAA000605	400 €
RH630/2R	HEDA000603	1,037 €	HEGA000221	1,261 €	HEGA000602	322 €	HEAA000223	400 €	HEAA000604	426 €
RH630/2	HEDA000602	1,037 €	HEGA000220	1,261 €	HEGA000601	300 €	HEAA000222	400 €	HEAA000603	426 €

ZM - Ventilatoren

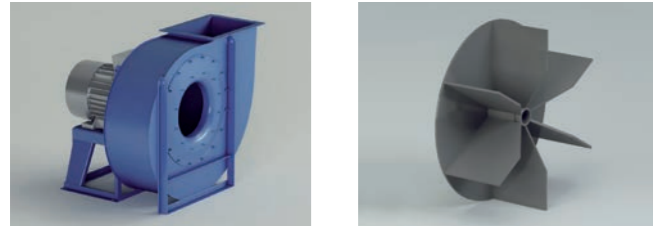

- **Arbeitsbereich :**
Mittlere Fördermengen. Mittlere Drücke.
- **Laufrad :**
grade, offen.
- **Anwendungen :**
Zum Transport von in Luft vermischten Feststoffen, Sägestaub und Holzspäne, auch für fadenförmige Materialien, die einen geschlossenen Ventilator mit rückwärts gekrümmten Schaufeln zusetzen würden.
- **Technische Spezifikationen :**
Luftvolumen : 200 bis 65.000 m³/h.
Gesamtdruck : 300 bis 500 daPa.

Ventilator	Max-Umdrehungen (rpm)
Größe	KLASSE III
ZM220	5000
ZM250	5000
ZM280	4750
ZM310	4250
ZM350	4000
ZM400	3500
ZM450	3500

Ventilator	Max-Umdrehungen (rpm)
Größe	KLASSE III
ZM500	3150
ZM560	2940
ZM630	2800
ZM710	2300
ZM800	2000
ZM900	1700
ZM1000	1550

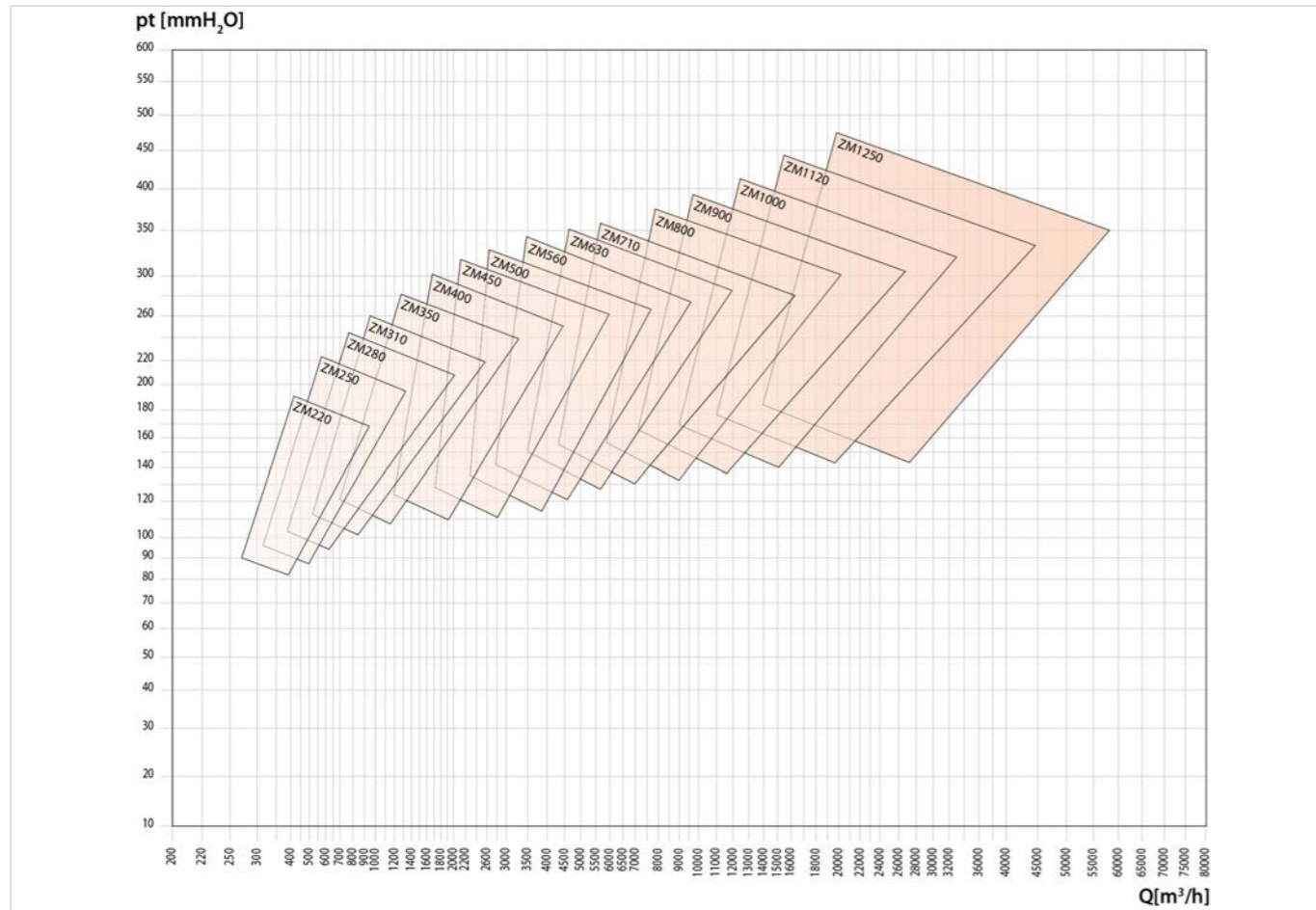

! Dieser Ventilator hat Bereich KLASSE III Laufrad Ausführungen als Standard.

Typ	Gr	kW	Pole	EX4		EX5		ID		HT	
				Code	Preis	Code	Preis	Code	Preis	Code	Preis
ZM220/2	71	0,37	2	HBAA003607	284 €	HBAB000210	265 €	HDCA000226	57 €	HDEA000225	111 €
ZM250/2R	71	0,55	2	HBAA003639	339 €	HBAB000212	311 €	HDCA000228	57 €	HDEA000227	111 €
ZM250/2	80	0,75	2	HBAA003623	339 €	HBAB000211	311 €	HDCA000227	57 €	HDEA000226	111 €
ZM280/2R	80	1,1	2	HBAA003671	399 €	HBAB000214	368 €	HDCA000230	57 €	HDEA000229	111 €
ZM280/2	90	1,5	2	HBAA003655	399 €	HBAB000213	368 €	HDCA000229	57 €	HDEA000228	174 €
ZM310/2R	90	1,5	2	HBAA003703	448 €	HBAB000216	414 €	HDCA000232	64 €	HDEA000231	174 €
ZM310/2	90	2,2	2	HBAA003687	448 €	HBAB000215	414 €	HDCA000231	64 €	HDEA000230	174 €
ZM350/2R	100	3	2	HBAA003735	566 €	HBAB000218	528 €	HDCA000234	64 €	HDEA000233	174 €
ZM350/2	112	4	2	HBAA003719	566 €	HBAB000217	528 €	HDCA000233	64 €	HDEA000232	174 €
ZM400/2R	132	5,5	2	HBAA003767	721 €	HBAB000220	676 €	HDCA000236	73 €	HDEA000235	276 €
ZM400/2	132	7,5	2	HBAA003751	721 €	HBAB000219	676 €	HDCA000235	73 €	HDEA000234	276 €
ZM450/4R	90	1,5	4	HBAA003847	904 €	HBAB000225	853 €	HDCA000241	73 €	HDEA000240	174 €
ZM450/2R	132	9,2	2	HBAA003799	904 €	HBAB000222	853 €	HDCA000238	73 €	HDEA000237	276 €
ZM450/2	160	11	2	HBAA003783	949 €	HBAB000221	904 €	HDCA000237	73 €	HDEA000236	276 €
ZM500/4R	100	2,2	4	HBAA003879	1,065 €	HBAB000227	997 €	HDCA000243	90 €	HDEA000242	174 €
ZM500/4	100	3	4	HBAA003863	1,065 €	HBAB000226	997 €	HDCA000242	90 €	HDEA000241	174 €
ZM500/2R	160	15	2	HBAA003831	1,120 €	HBAB000224	997 €	HDCA000240	90 €	HDEA000239	276 €
ZM500/2	180	22	2	HBAA003815	1,120 €	HBAB000223	1,049 €	HDCA000239	90 €	HDEA000238	276 €
ZM560/4R	112	4	4	HBAA003911	1,610 €	HBAB000229	1,435 €	HDCA000245	113 €	HDEA000244	174 €
ZM560/4	132	5,5	4	HBAA003895	1,610 €	HBAB000228	1,435 €	HDCA000244	113 €	HDEA000243	276 €
ZM630/4R	132	7,5	4	HBAA003943	1,964 €	HBAB000231	2,019 €	HDCA000247	113 €	HDEA000246	276 €
ZM630/4	160	11	4	HBAA003927	1,964 €	HBAB000230	2,019 €	HDCA000246	113 €	HDEA000245	276 €
ZM710/4R	160	11	4	HBAA003975	2,593 €	HBAB000233	2,472 €	HDCA000249	C	HDEA000248	276 €
ZM710/4	160	15	4	HBAA003959	2,593 €	HBAB000232	2,472 €	HDCA000248	C	HDEA000247	276 €
ZM800/4R	180	18,5	4	HBAA004007	3,112 €	HBAB000235	3,007 €	HDCA000251	C	HDEA000250	276 €
ZM800/4	200	30	4	HBAA003991	3,112 €	HBAB000234	3,196 €	HDCA000250	C	HDEA000249	368 €
ZM900/4R	225	37	4	HBAA004039	4,141 €	HBAB000237	4,113 €	HDCA000253	C	HDEA000252	368 €
ZM900/4	225	45	4	HBAA004023	4,141 €	HBAB000236	4,113 €	HDCA000252	C	HDEA000251	368 €
ZM1000/4R	250	55	4	HBAA004071	4,871 €	HBAB000238	4,679 €	HDCA000255	C	HDEA000254	368 €
ZM1000/4	280	75	4	HBAA004055	5,352 €	N	N	HDCA000254	C	HDEA000253	431 €

Typ	TEN		DP		WC		FS		Extra 2GD EX.4	
	Code	Preis	Code	Preis	Code	Preis	Code	Preis	Code	Preis
ZM220/2	HGBA000227	111 €	HDDA000226	49 €	HDBA000226	99 €	HDAA000224	74 €	HEDA000225	553 €
ZM250/2R	HGBA000229	111 €	HDDA000228	49 €	HDBA000228	112 €	HDAA000226	76 €	HEDA000227	578 €
ZM250/2	HGBA000228	111 €	HDDA000227	49 €	HDBA000227	112 €	HDAA000225	76 €	HEDA000226	578 €
ZM280/2R	HGBA000231	111 €	HDDA000230	49 €	HDBA000230	123 €	HDAA000228	76 €	HEDA000229	622 €
ZM280/2	HGBA000230	174 €	HDDA000229	49 €	HDBA000229	123 €	HDAA000227	76 €	HEDA000228	685 €
ZM310/2R	HGBA000233	174 €	HDDA000232	49 €	HDBA000232	137 €	HDAA000230	80 €	HEDA000231	724 €
ZM310/2	HGBA000232	174 €	HDDA000231	49 €	HDBA000231	137 €	HDAA000229	80 €	HEDA000230	724 €
ZM350/2R	HGBA000235	174 €	HDDA000234	49 €	HDBA000234	167 €	HDAA000232	91 €	HEDA000233	778 €
ZM350/2	HGBA000234	174 €	HDDA000233	49 €	HDBA000233	167 €	HDAA000231	91 €	HEDA000232	778 €
ZM400/2R	HGBA000237	276 €	HDDA000236	49 €	HDBA000236	167 €	HDAA000234	92 €	HEDA000235	956 €
ZM400/2	HGBA000236	276 €	HDDA000235	49 €	HDBA000235	167 €	HDAA000233	92 €	HEDA000234	956 €
ZM450/4R	HGBA000242	174 €	HDDA000241	49 €	HDBA000241	207 €	HDAA000239	101 €	HEDA000240	910 €
ZM450/2R	HGBA000238	276 €	HDDA000238	49 €	HDBA000238	207 €	HDAA000236	101 €	HEDA000237	1,012 €
ZM450/2	HGBA000239	276 €	HDDA000237	49 €	HDBA000237	207 €	HDAA000235	101 €	HEDA000236	1,012 €
ZM500/4R	HGBA000244	174 €	HDDA000243	49 €	HDBA000243	204 €	HDAA000241	108 €	HEDA000242	958 €
ZM500/4	HGBA000243	174 €	HDDA000242	49 €	HDBA000242	204 €	HDAA000240	108 €	HEDA000241	958 €
ZM500/2R	HGBA000241	276 €	HDDA000240	49 €	HDBA000240	204 €	HDAA000238	108 €	HEDA000239	1,060 €
ZM500/2	HGBA000240	276 €	HDDA000239	49 €	HDBA000239	204 €	HDAA000237	108 €	HEDA000238	1,060 €
ZM560/4R	HGBA000246	174 €	HDDA000245	49 €	HDBA000245	262 €	HDAA000243	C	HEDA000244	1,123 €
ZM560/4	HGBA000245	276 €	HDDA000244	49 €	HDBA000244	262 €	HDAA000242	C	HEDA000243	1,225 €
ZM630/4R	HGBA000248	276 €	HDDA000247	49 €	HDBA000247	290 €	HDAA000245	C	HEDA000246	1,288 €
ZM630/4	HGBA000247	276 €	HDDA000246	49 €	HDBA000246	290 €	HDAA000244	C	HEDA000245	1,288 €
ZM710/4R	HGBA000250	276 €	HDDA000249	78 €	HDBA000249	C	HDAA000247	C	HEDA000248	911 €
ZM710/4	HGBA000249	276 €	HDDA000248	78 €	HDBA000248	C	HDAA000246	C	HEDA000247	911 €
ZM800/4R	HGBA000252	276 €	HDDA000251	78 €	HDBA000251	C	HDAA000249	C	HEDA000250	1,018 €
ZM800/4	HGBA000251	368 €	HDDA000250	78 €	HDBA000250	C	HDAA000248	C	HEDA000249	1,110 €
ZM900/4R	HGBA000254	368 €	HDDA000253	78 €	HDBA000253	C	HDAA000251	C	HEDA000252	1,182 €
ZM900/4	HGBA000253	368 €	HDDA000252	78 €	HDBA000252	C	HDAA000250	C	HEDA000251	1,182 €
ZM1000/4R	HGBA000256	368 €	HDDA000255	78 €	HDBA000255	C	HDAA000253	C	HEDA000254	1,390 €
ZM1000/4	HGBA000255	431 €	HDDA000254	78 €	HDBA000254	C	HDAA000252	C	HEDA000253	1,453 €

Typ	Extra 2GD EX.5		Extra 3GD EX.4		Extra 3GD EX.5		Extra Tipo C EX.4		Extra Tipo C EX.5	
	Code	Preis	Code	Preis	Code	Preis	Code	Preis	Code	Preis
ZM220/2	HEDA000606	435 €	HEGA000224	335 €	HEGA000605	217 €	HEAA000226	130 €	HEAA000607	123 €
ZM250/2R	HEDA000608	461 €	HEGA000226	347 €	HEGA000607	230 €	HEAA000228	141 €	HEAA000609	134 €
ZM250/2	HEDA000607	475 €	HEGA000225	347 €	HEGA000606	244 €	HEAA000227	141 €	HEAA000608	148 €
ZM280/2R	HEDA000610	517 €	HEGA000228	379 €	HEGA000609	274 €	HEAA000230	164 €	HEAA000611	169 €
ZM280/2	HEDA000609	517 €	HEGA000227	379 €	HEGA000608	274 €	HEAA000229	164 €	HEAA000610	169 €
ZM310/2R	HEDA000612	556 €	HEGA000230	468 €	HEGA000611	300 €	HEAA000232	182 €	HEAA000613	188 €
ZM310/2	HEDA000611	556 €	HEGA000229	468 €	HEGA000610	300 €	HEAA000231	182 €	HEAA000612	188 €
ZM350/2R	HEDA000614	641 €	HEGA000232	493 €	HEGA000613	356 €	HEAA000234	206 €	HEAA000615	242 €
ZM350/2	HEDA000613	641 €	HEGA000231	493 €	HEGA000612	356 €	HEAA000233	206 €	HEAA000614	242 €
ZM400/2R	HEDA000616	713 €	HEGA000234	671 €	HEGA000615	427 €	HEAA000236	253 €	HEAA000617	286 €
ZM400/2	HEDA000615	713 €	HEGA000233	671 €	HEGA000614	427 €	HEAA000235	253 €	HEAA000616	286 €
ZM450/4R	HEDA000621	711 €	HEGA000238	686 €	HEGA000619	385 €	HEAA000240	266 €	HEAA000621	241 €
ZM450/2R	HEDA000618	766 €	N	N	N	N	N	N	N	N
ZM450/2	HEDA000617	790 €	HEGA000235	893 €	HEGA000616	671 €	HEAA000237	266 €	HEAA000618	319 €
ZM500/4R	HEDA000623	792 €	HEGA000240	707 €	HEGA000621	440 €	HEAA000242	270 €	HEAA000623	279 €
ZM500/4	HEDA000622	792 €	HEGA000239	707 €	HEGA000620	440 €	HEAA000241	270 €	HEAA000622	279 €
ZM500/2R	HEDA000620	837 €	HEGA000237	941 €	HEGA000618	718 €	HEAA000239	270 €	HEAA000620	323 €
ZM500/2	HEDA000619	837 €	HEGA000236	941 €	HEGA000617	718 €	HEAA000238	270 €	HEAA000619	323 €
ZM560/4R	HEDA000625	906 €	HEGA000242	742 €	HEGA000623	525 €	HEAA000244	367 €	HEAA000625	323 €
ZM560/4	HEDA000624	927 €	HEGA000241	742 €	HEGA000622	546 €	HEAA000243	367 €	HEAA000624	344 €
ZM630/4R	HEDA000627	988 €	HEGA000244	879 €	HEGA000625	580 €	HEAA000246	400 €	HEAA000627	377 €
ZM630/4	HEDA000626	1,012 €	HEGA000243	1,169 €	HEGA000624	893 €	HEAA000245	400 €	HEAA000626	400 €
ZM710/4R	HEDA000629	630 €	HEGA000246	792 €	HEGA000627	511 €	HEAA000248	424 €	HEAA000629	419 €
ZM710/4	HEDA000628	630 €	HEGA000245	792 €	HEGA000626	511 €	HEAA000247	424 €	HEAA000628	419 €
ZM800/4R	HEDA000631	651 €	HEGA000248	899 €	HEGA000629	532 €	HEAA000250	514 €	HEAA000631	423 €
ZM800/4	HEDA000630	676 €	HEGA000247	991 €	HEGA000628	557 €	HEAA000249	514 €	HEAA000630	448 €
ZM900/4R	N	N	HEGA000250	1,063 €	N	N	HEAA000252	561 €	HEAA000633	531 €
ZM900/4	N	N	HEGA000249	1,063 €	N	N	HEAA000251	561 €	HEAA000632	531 €
ZM1000/4R	N	N	HEGA000252	1,250 €	N	N	HEAA000254	741 €	HEAA000634	587 €
ZM1000/4	N	N	HEGA000251	1,313 €	N	N	HEAA000253	741 €	N	N

ZC - Ventilatoren

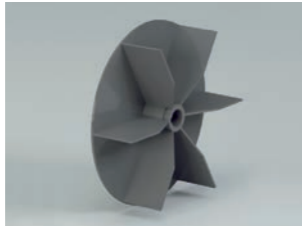
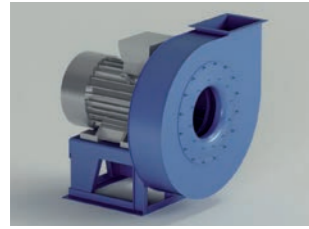

- **Arbeitsbereich :**
Mittlere - niedrige Fördermengen. Mittlere - hohe Drücke.
- **Laufrad :**
grade, offen.
- **Anwendungen :**
Zum Transport von in Luft vermischten Feststoffen, Sägestaub und Holzspäne, auch für fadenförmige Materialien, die einen geschlossenen Ventilator mit rückwärts gekrümmten Schaufeln zusetzen würden.
- **Technische Spezifikationen :**
Luftvolumen : 1.500 bis 50.000 m³/h.
Gesamtdruck : 100 bis 450 daPa.

Ventilator	Max-Umdrehungen (rpm)
Größe	KLASSE I
ZC400	3280
ZC450	3430
ZC500	3060
ZC560	2960
ZC630	2450

Ventilator	Max-Umdrehungen (rpm)
Größe	KLASSE I
ZC710	2150
ZC800	1910
ZC900	1700
ZC1000	1530

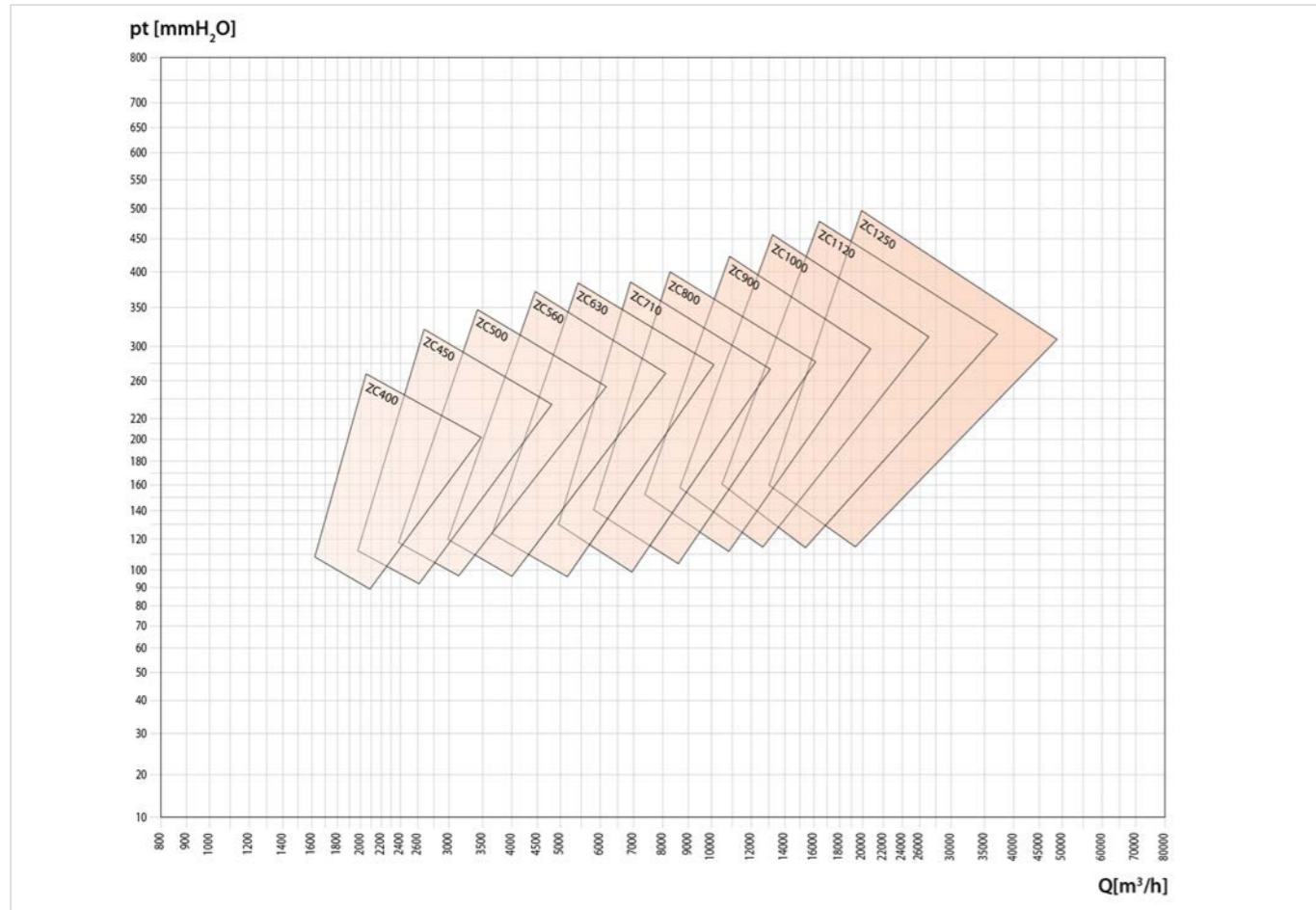

Typ	Gr	kW	Pole	EX4		EX5		ID		HT	
				Code	Preis	Code	Preis	Code	Preis	Code	Preis
ZC400/2R	112	4	2	HBAA005437	781 €	HBAB000313	736 €	HDCA000339	73 €	HDEA000346	276 €
ZC400/2	132	5,5	2	HBAA005421	781 €	HBAB000312	736 €	HDCA000338	73 €	HDEA000345	276 €
ZC450/2R	132	7,5	2	HBAA005469	979 €	HBAB000315	927 €	HDCA000341	73 €	HDEA000348	276 €
ZC450/2	160	11	2	HBAA005453	1,023 €	HBAB000314	979 €	HDCA000340	73 €	HDEA000347	276 €
ZC500/2R	160	11	2	HBAA005501	1,190 €	HBAB000317	1,067 €	HDCA000343	90 €	HDEA000350	276 €
ZC500/2	160	18,5	2	HBAA005485	1,190 €	HBAB000316	1,067 €	HDCA000342	90 €	HDEA000349	276 €
ZC560/4	112	4	4	HBAA005549	1,645 €	HBAB000320	1,470 €	HDCA000346	113 €	HDEA000353	174 €
ZC560/2R	180	22	2	HBAA005533	1,719 €	HBAB000319	1,693 €	HDCA000345	113 €	HDEA000352	276 €
ZC560/2	200	30	2	HBAA005517	1,719 €	HBAB000318	1,817 €	HDCA000344	113 €	HDEA000351	368 €
ZC630/4R	132	5,5	4	HBAA005581	2,150 €	HBAB000322	2,205 €	HDCA000348	113 €	HDEA000355	276 €
ZC630/4	132	7,5	4	HBAA005565	2,150 €	HBAB000321	2,205 €	HDCA000347	113 €	HDEA000354	276 €
ZC710/4R	160	11	4	HBAA005613	2,794 €	HBAB000324	2,674 €	HDCA000350	C	HDEA000357	276 €
ZC710/4	160	15	4	HBAA005597	2,794 €	HBAB000323	2,674 €	HDCA000349	C	HDEA000356	276 €
ZC800/4R	180	22	4	HBAA005645	3,427 €	HBAB000326	3,322 €	HDCA000352	C	HDEA000359	276 €
ZC800/4	200	30	4	HBAA005629	3,427 €	HBAB000325	3,511 €	HDCA000351	C	HDEA000358	368 €
ZC900/4R	225	37	4	HBAA005677	4,306 €	HBAB000328	4,278 €	HDCA000354	C	HDEA000361	368 €
ZC900/4	225	45	4	HBAA005661	4,306 €	HBAB000327	4,278 €	HDCA000353	C	HDEA000360	368 €
ZC1000/4R	225	45	4	HBAA005709	4,984 €	HBAB000330	5,022 €	HDCA000356	C	HDEA000363	368 €
ZC1000/4	250	55	4	HBAA005693	4,984 €	HBAB000329	5,022 €	HDCA000355	C	HDEA000362	368 €

Typ	TEN		DP		WC		FS		Extra 2GD EX.4	
	Code	Preis	Code	Preis	Code	Preis	Code	Preis	Code	Preis
ZC400/2R	HGBA000348	276 €	HDDA000339	49 €	HDBA000341	207 €	HDAA000340	92 €	HEDA000336	854 €
ZC400/2	HGBA000347	174 €	HDDA000338	49 €	HDBA000340	167 €	HDAA000339	92 €	HEDA000335	956 €
ZC450/2R	HGBA000350	276 €	HDDA000341	49 €	HDBA000343	207 €	HDAA000342	101 €	HEDA000338	1,012 €
ZC450/2	HGBA000349	276 €	HDDA000340	49 €	HDBA000342	207 €	HDAA000341	101 €	HEDA000337	1,012 €
ZC500/2R	HGBA000352	276 €	HDDA000343	49 €	HDBA000345	204 €	HDAA000344	108 €	HEDA000340	1,060 €
ZC500/2	HGBA000351	276 €	HDDA000342	49 €	HDBA000344	204 €	HDAA000343	108 €	HEDA000339	1,060 €
ZC560/4	HGBA000355	174 €	HDDA000346	49 €	HDBA000348	262 €	HDAA000347	C	HEDA000343	1,123 €
ZC560/2R	HGBA000354	276 €	HDDA000345	49 €	HDBA000347	262 €	HDAA000346	C	HEDA000342	1,225 €
ZC560/2	HGBA000353	368 €	HDDA000344	49 €	HDBA000346	262 €	HDAA000345	C	HEDA000341	1,317 €
ZC630/4R	HGBA000357	276 €	HDDA000348	49 €	HDBA000350	290 €	HDAA000349	C	HEDA000345	1,288 €
ZC630/4	HGBA000356	276 €	HDDA000347	49 €	HDBA000349	290 €	HDAA000348	C	HEDA000344	1,288 €
ZC710/4R	HGBA000359	276 €	HDDA000350	78 €	HDBA000352	C	HDAA000351	C	HEDA000347	911 €
ZC710/4	HGBA000358	276 €	HDDA000349	78 €	HDBA000351	C	HDAA000350	C	HEDA000346	911 €
ZC800/4R	HGBA000361	276 €	HDDA000352	78 €	HDBA000354	C	HDAA000353	C	HEDA000349	1,018 €
ZC800/4	HGBA000360	368 €	HDDA000351	78 €	HDBA000353	C	HDAA000352	C	HEDA000348	1,110 €
ZC900/4R	HGBA000363	368 €	HDDA000354	78 €	HDBA000356	C	HDAA000355	C	HEDA000351	1,158 €
ZC900/4	HGBA000362	368 €	HDDA000353	78 €	HDBA000355	C	HDAA000354	C	HEDA000350	1,158 €
ZC1000/4R	HGBA000365	368 €	HDDA000356	78 €	HDBA000358	C	HDAA000357	C	HEDA000353	1,390 €
ZC1000/4	HGBA000364	368 €	HDDA000355	78 €	HDBA000357	C	HDAA000356	C	HEDA000352	1,390 €

Typ	Extra 2GD EX.5		Extra 3GD EX.4		Extra 3GD EX.5		Extra Tipo C EX.4		Extra Tipo C EX.5	
	Code	Preis	Code	Preis	Code	Preis	Code	Preis	Code	Preis
ZC400/2R	HEDA000696	619 €	HEGA000334	568 €	HEGA000694	1,201 €	HEAA000336	253 €	HEAA000699	265 €
ZC400/2	HEDA000695	640 €	HEGA000333	568 €	HEGA000693	1,070 €	HEAA000335	253 €	HEAA000698	286 €
ZC450/2R	HEDA000698	693 €	HEGA000336	686 €	HEGA000696	1,224 €	HEAA000338	266 €	HEAA000701	295 €
ZC450/2	HEDA000697	717 €	HEGA000335	893 €	HEGA000695	1,070 €	HEAA000337	266 €	HEAA000700	319 €
ZC500/2R	HEDA000700	748 €	HEGA000338	941 €	HEGA000698	235 €	HEAA000340	270 €	HEAA000703	323 €
ZC500/2	HEDA000699	748 €	HEGA000337	941 €	HEGA000697	235 €	HEAA000339	270 €	HEAA000702	323 €
ZC560/4	HEDA000703	792 €	HEGA000341	844 €	HEGA000701	270 €	HEAA000343	367 €	HEAA000706	323 €
ZC560/2R	HEDA000702	837 €	HEGA000340	1,106 €	HEGA000700	267 €	HEAA000342	367 €	HEAA000705	368 €
ZC560/2	HEDA000701	862 €	HEGA000339	1,106 €	HEGA000699	253 €	HEAA000341	367 €	HEAA000704	393 €
ZC630/4R	HEDA000705	875 €	HEGA000343	879 €	HEGA000703	314 €	HEAA000345	400 €	HEAA000708	377 €
ZC630/4	HEDA000704	875 €	HEGA000342	879 €	HEGA000702	314 €	HEAA000344	400 €	HEAA000707	377 €
ZC710/4R	HEDA000707	630 €	HEGA000345	792 €	HEGA000705	385 €	HEAA000347	424 €	HEAA000710	419 €
ZC710/4	HEDA000706	630 €	HEGA000344	792 €	HEGA000704	314 €	HEAA000346	424 €	HEAA000709	419 €
ZC800/4R	HEDA000709	651 €	HEGA000347	899 €	HEGA000707	532 €	HEAA000349	514 €	HEAA000712	423 €
ZC800/4	HEDA000708	676 €	HEGA000346	899 €	HEGA000706	385 €	HEAA000348	514 €	HEAA000711	448 €
ZC900/4R	N	N	HEGA000349	1,039 €	N	N	HEAA000351	561 €	HEAA000714	531 €
ZC900/4	N	N	HEGA000348	1,039 €	N	N	HEAA000350	561 €	HEAA000713	531 €
ZC1000/4R	N	N	HEGA000351	1,250 €	N	N	HEAA000353	741 €	HEAA000716	554 €
ZC1000/4	N	N	HEGA000350	1,250 €	N	N	HEAA000352	741 €	HEAA000715	554 €

VI/N - Ventilatoren

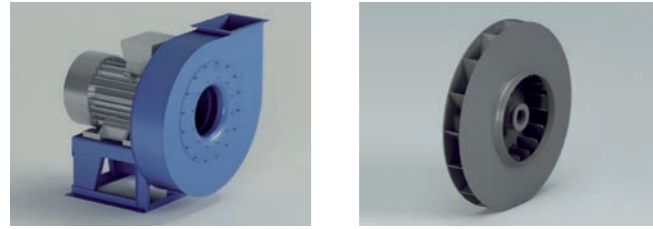

Arbeitsbereich :
Niedrige - mittlere Fördermengen. Hohe Drücke.
Schaufelform :
Kurve, rückwärts gekrümmt mit Deckel.
Anwendungen :
Zum Transport von Stäuben, zur Trocknung und für mit Überdruck zu beaufschlagende Räume. Zur Verwendung im industriellen Bereich, Giessereien, Nudelfabriken, Öfen und der Chemie geeignet.
Technische Spezifikationen :
Luftvolumen : 850 bis 180.000 m³/h.
Gesamtdruck : 100 bis 1.800 daPa.

Ventilator	Max-Umdrehungen (rpm)		
	Größe	KLASSE I	KLASSE II
VI400	5000	-	-
VI450/R	5000	-	-
VI450	5000	-	-
VI500/R	4750	-	-
VI500	4500	5000	-
VI560/R	4250	4750	-
VI560	4000	4500	-
VI630/R	3850	4150	4500
VI630	3700	3900	4250
VI710/R	3550	3850	4150
VI710	3400	3700	4000

Ventilator	Max-Umdrehungen (rpm)		
	Größe	KLASSE I	KLASSE II
VI800/R	3250	3550	3850
VI800	3000	3300	3600
VI900/R	3200	3500	3700
VI900	3000	3250	3450
VI1000/R	3150	3350	3450
VI1000	3000	3150	3350
VI1120	2700	2900	3100
VI1250	2400	2600	2800
VI1400	2100	2300	2450
VI1600	1850	2000	2100

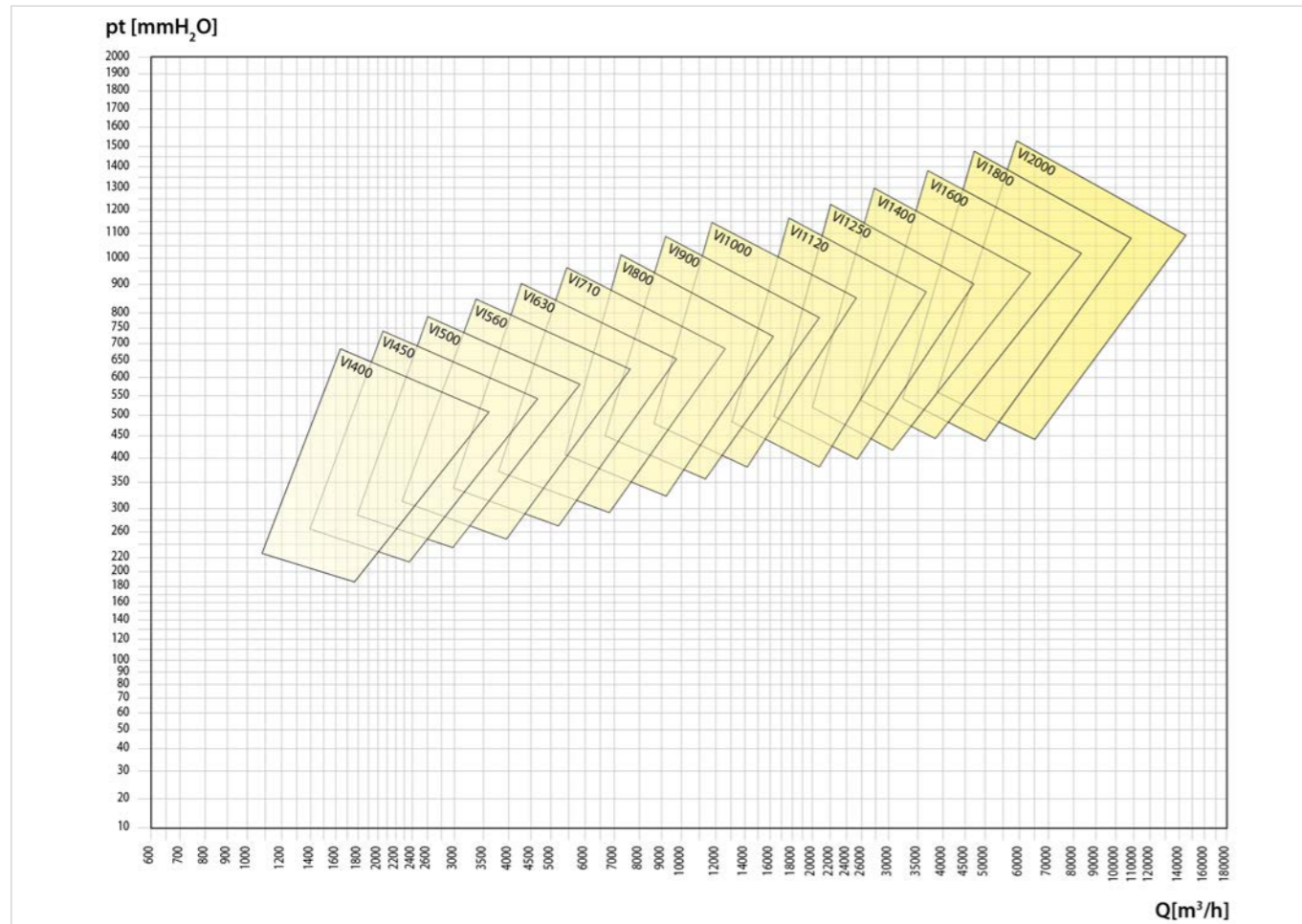

Typ	Gr	kW	Pole	EX4		EX5		ID		HT	
				Code	Preis	Code	Preis	Code	Preis	Code	Preis
VIN400/2	90	2,2	2	HBAA005725	858 €	HBAB000331	794 €	HDCA000357	57 €	HDEA000364	174 €
VIN450/2	100	3	2	HBAA005739	1,057 €	HBAB000332	967 €	HDCA000358	57 €	HDEA000365	174 €
VIN500/2R	112	4	2	HBAA005767	1,218 €	HBAB000334	1,112 €	HDCA000360	64 €	HDEA000367	174 €
VIN500/2	132	5,5	2	HBAA005753	1,218 €	HBAB000333	1,112 €	HDCA000359	64 €	HDEA000366	276 €
VIN560/2R	132	7,5	2	HBAA005795	1,596 €	HBAB000336	1,511 €	HDCA000362	64 €	HDEA000370	276 €
VIN560/2	160	11	2	HBAA005781	1,596 €	HBAB000335	1,511 €	HDCA000361	64 €	HDEA000369	276 €
VIN630/2R	160	15	2	HBAA005837	2,029 €	HBAB000338	1,896 €	HDCA000364	90 €	HDEA000372	276 €
VIN630/2	160	18,5	2	HBAA005809	2,029 €	HBAB000337	1,896 €	HDCA000363	90 €	HDEA000371	276 €
VIN710/2R	180	22	2	HBAA005867	2,696 €	HBAB000340	2,500 €	HDCA000366	90 €	HDEA000374	276 €
VIN710/2	200	30	2	HBAA005851	2,867 €	HBAB000339	2,621 €	HDCA000365	90 €	HDEA000373	368 €
VIN800/2R	225	45	2	HBAA005915	4,323 €	HBAB000343	4,305 €	HDCA000368	90 €	HDEA000378	368 €
VIN800/2	250	55	2	HBAA005899	4,323 €	HBAB000342	4,305 €	HDCA000367	90 €	HDEA000376	431 €
VIN900/2R	280	90	2	HBAA005947	6,416 €	HBAB000344	6,205 €	HDCA000370	90 €	HDEA000380	431 €
VIN900/2	315	110	2	HBAA005931	6,416 €	N	N	HDCA000369	90 €	HDEA000379	431 €
VIN1000/2R	315	160	2	HBAA005979	7,617 €	N	N	HDCA000372	113 €	HDEA000382	431 €
VIN1000/2	315	200	2	HBAA005963	7,617 €	N	N	HDCA000371	113 €	HDEA000381	431 €
VIN1120/4	225	200	4	HBAA006011	9,755 €	N	N	HDCA000374	113 €	HDEA000384	431 €
VIN1120/2	315	200	2	HBAA005995	11,175 €	N	N	HDCA000373	113 €	HDEA000383	431 €
VIN1250/4	280	200	4	HBAA006027	12,732 €	N	N	HDCA000375	113 €	HDEA000385	431 €
VIN1400/4	315	200	4	HBAA006043	14,981 €	N	N	HDCA000376	113 €	HDEA000386	487 €
VIN1600/4	315	200	4	HBAA006059	21,603 €	N	N	HDCA000377	113 €	HDEA000387	487 €

Typ	TEN		DP		WC		FS		Extra 2GD EX.4	
	Code	Preis	Code	Preis	Code	Preis	Code	Preis	Code	Preis
VIN400/2	HGBA000366	174 €	HDDA000357	49 €	HDBA000359	167 €	HDAA000358	85 €	HEDA000354	787 €
VIN450/2	HGBA000367	174 €	HDDA000358	49 €	HDBA000360	207 €	HDAA000359	92 €	HEDA000355	847 €
VIN500/2R	HGBA000369	174 €	HDDA000360	49 €	HDBA000362	204 €	HDAA000361	102 €	HEDA000357	909 €
VIN500/2	HGBA000368	276 €	HDDA000359	49 €	HDBA000361	204 €	HDAA000360	102 €	HEDA000356	1,011 €
VIN560/2R	HGBA000372	276 €	HDDA000362	49 €	HDBA000364	262 €	HDAA000363	108 €	HEDA000359	1,117 €
VIN560/2	HGBA000371	276 €	HDDA000361	49 €	HDBA000363	262 €	HDAA000362	108 €	HEDA000358	1,117 €
VIN630/2R	HGBA000374	276 €	HDDA000364	49 €	HDBA000366	290 €	HDAA000365	111 €	HEDA000361	1,173 €
VIN630/2	HGBA000373	276 €	HDDA000363	49 €	HDBA000365	290 €	HDAA000364	111 €	HEDA000360	1,173 €
VIN710/2R	HGBA000376	276 €	HDDA000366	78 €	HDBA000368	C	HDAA000367	161 €	HEDA000363	935 €
VIN710/2	HGBA000375	368 €	HDDA000365	78 €	HDBA000367	C	HDAA000366	161 €	HEDA000362	1,028 €
VIN800/2R	HGBA000379	368 €	HDDA000368	78 €	HDBA000370	C	HDAA000369	196 €	HEDA000365	1,180 €
VIN800/2	HGBA000377	368 €	HDDA000367	78 €	HDBA000369	C	HDAA000368	196 €	HEDA000364	1,180 €
VIN900/2R	HGBA000381	431 €	HDDA000370	78 €	HDBA000372	C	HDAA000371	253 €	HEDA000367	1,273 €
VIN900/2	HGBA000380	431 €	HDDA000369	78 €	HDBA000371	C	HDAA000370	253 €	HEDA000366	1,273 €
VIN1000/2R	HGBA000383	431 €	HDDA000372	78 €	HDBA000374	C	HDAA000373	266 €	HEDA000369	1,515 €
VIN1000/2	HGBA000382	431 €	HDDA000371	78 €	HDBA000373	C	HDAA000372	266 €	HEDA000368	1,515 €
VIN1120/4	HGBA000385	431 €	HDDA000374	78 €	HDBA000376	C	HDAA000375	C	HEDA000370	1,970 €
VIN1120/2	HGBA000384	431 €	HDDA000373	78 €	HDBA000375	C	HDAA000374	C	N	N
VIN1250/4	HGBA000386	431 €	HDDA000375	78 €	HDBA000377	C	HDAA000376	C	HEDA000371	2,002 €
VIN1400/4	HGBA000387	487 €	HDDA000376	78 €	HDBA000378	C	HDAA000377	C	HEDA000372	2,479 €
VIN1600/4	HGBA000388	487 €	HDDA000377	78 €	HDBA000379	C	HDAA000378	C	HEDA000373	2,881 €

Typ	Extra 2GD EX.5		Extra 3GD EX.4		Extra 3GD EX.5		Extra Tipo C EX.4		Extra Tipo C EX.5	
	Code	Preis	Code	Preis	Code	Preis	Code	Preis	Code	Preis
VIN400/2	HEDA000710	592 €	HEGA000352	501 €	HEGA000708	307 €	HEAA000354	204 €	HEAA000717	183 €
VIN450/2	HEDA000711	685 €	HEGA000353	521 €	HEGA000709	358 €	HEAA000355	223 €	HEAA000718	234 €
VIN500/2R	HEDA000713	743 €	HEGA000355	556 €	HEGA000711	400 €	HEAA000357	249 €	HEAA000720	258 €
VIN500/2	HEDA000712	763 €	HEGA000354	658 €	HEGA000710	410 €	HEAA000356	249 €	HEAA000719	277 €
VIN560/2R	HEDA000715	818 €	HEGA000357	736 €	HEGA000713	451 €	HEAA000359	311 €	HEAA000722	287 €
VIN560/2	HEDA000714	841 €	HEGA000356	998 €	HEGA000712	475 €	HEAA000358	311 €	HEAA000721	311 €
VIN630/2R	HEDA000717	897 €	HEGA000359	1,054 €	HEGA000715	791 €	HEAA000361	314 €	HEAA000724	314 €
VIN630/2	HEDA000716	897 €	HEGA000358	1,054 €	HEGA000714	791 €	HEAA000360	314 €	HEAA000723	314 €
VIN710/2R	HEDA000719	657 €	HEGA000361	816 €	HEGA000717	554 €	HEAA000363	363 €	HEAA000726	360 €
VIN710/2	HEDA000718	679 €	HEGA000360	909 €	HEGA000716	578 €	HEAA000362	363 €	HEAA000725	382 €
VIN800/2R	HEDA000720	777 €	HEGA000363	1,061 €	HEGA000718	685 €	HEAA000365	497 €	HEAA000727	462 €
VIN800/2	N	N	HEGA000362	1,061 €	N	N	HEAA000364	497 €	N	N
VIN900/2R	N	N	HEGA000365	1,154 €	N	N	HEAA000367	522 €	N	N
VIN900/2	N	N	HEGA000364	1,154 €	N	N	HEAA000366	522 €	N	N
VIN1000/2R	N	N	HEGA000367	1,375 €	N	N	HEAA000369	687 €	N	N
VIN1000/2	N	N	HEGA000366	1,375 €	N	N	HEAA000368	687 €	N	N
VIN1120/4	N	N	HEGA000368	1,830 €	N	N	HEAA000370	1,137 €	N	N
VIN1120/2	N	N	N	N	N	N	N	N	N	N
VIN1250/4	N	N	HEGA000369	1,862 €	N	N	HEAA000371	1,168 €	N	N
VIN1400/4	N	N	HEGA000370	2,339 €	N	N	HEAA000372	1,557 €	N	N
VIN1600/4	N	N	HEGA000371	2,741 €	N	N	HEAA000373	1,956 €	N	N

VM - Ventilatoren

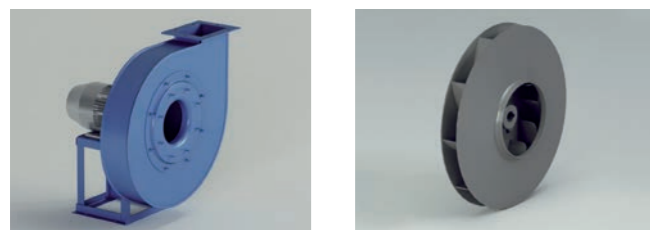

• **Arbeitsbereich :**
Niedrige - mittlere Fördermengen. Hohe Drücke

• **Laufrad :**
rückwärts gekrümmt, geschlossen.

Anwendungen :
Zum Transport von Stäuben, zur Trocknung und für mit Überdruck zu beaufschlagende Räume. Zur Verwendung im industriellen Bereich, Giessereien, Nudelfabriken, Öfen und der Chemie geeignet.

Technische Spezifikationen :
Luftvolumen : 360 bis 110.000 m³/h.
Gesamtdruck : 100 bis 2.200 daPa.

Ventilator	Max-Umdrehungen (rpm)		
	Größe	KLASSE I	KLASSE II
VM350/R	5000	-	-
VM350	5000	-	-
VM400/R	5000	-	-
VM400	5000	-	-
VM450/R	5000	-	-
VM450	5000	-	-
VM500/R	4750	-	-
VM500	4500	5000	-
VM560/R	42500	4750	-
VM560	4000	4500	-
VM630/R	3850	4150	4500
VM630	38700	3900	4250

Ventilator	Max-Umdrehungen (rpm)		
	Größe	KLASSE I	KLASSE II
VM710/R	3550	3850	4150
VM710	3400	3700	4000
VM800/R	3250	3550	3850
VM800	3000	3300	3600
VM900/R	3200	3500	3700
VM900	3000	3250	3450
VM1000/R	3150	3350	3450
VM1000	3000	3150	3350
VM1120	2700	2900	3100
VM1250	2400	2600	2800
VM1400	2100	2300	2450
VM1600	1850	2000	2100

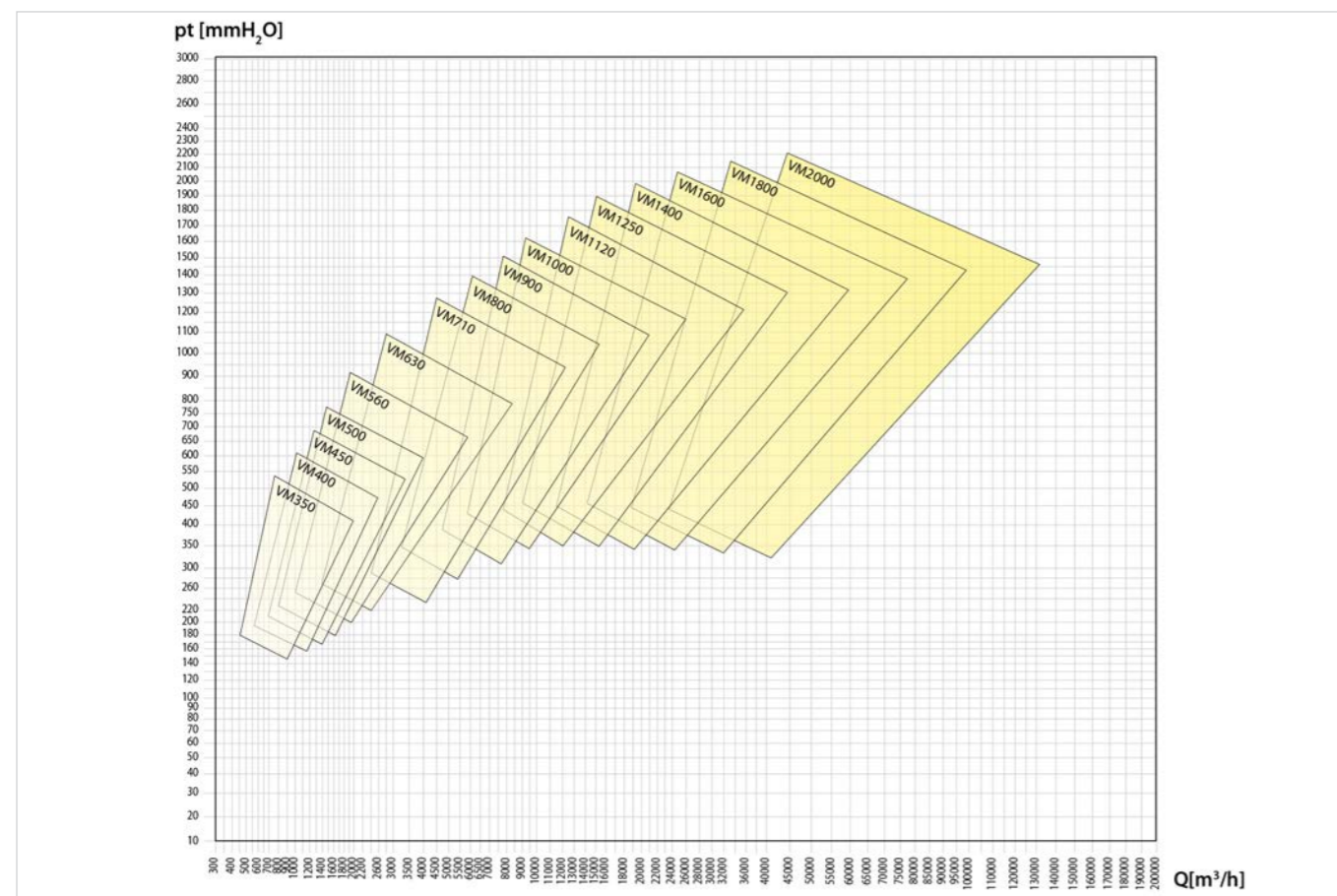

Typ	Gr	kW	Pole	EX4		EX5		ID		HT	
				Code	Preis	Code	Preis	Code	Preis	Code	Preis
VM350/2R	80	0,75	2	HBAA002255	529 €	HBAB000123	456 €	HDCA000141	57 €	HDEA000138	111 €
VM350/2	80	1,1	2	HBAA002241	514 €	HBAB000122	456 €	HDCA000140	57 €	HDEA000137	111 €
VM400/2R	90	1,5	2	HBAA002283	622 €	HBAB000125	540 €	HDCA000143	57 €	HDEA000140	174 €
VM400/2	90	2,2	2	HBAA002269	622 €	HBAB000124	540 €	HDCA000142	57 €	HDEA000139	174 €
VM450/2R	100	3	2	HBAA002311	825 €	HBAB000127	710 €	HDCA000145	57 €	HDEA000142	174 €
VM450/2	112	4	2	HBAA002297	825 €	HBAB000126	710 €	HDCA000144	57 €	HDEA000141	174 €
VM500/2R	112	4	2	HBAA002339	980 €	HBAB000129	839 €	HDCA000147	64 €	HDEA000144	174 €
VM500/2	132	5,5	2	HBAA002325	980 €	HBAB000128	839 €	HDCA000146	64 €	HDEA000143	276 €
VM560/2R	132	7,5	2	HBAA002367	1,379 €	HBAB000131	1,243 €	HDCA000149	64 €	HDEA000146	276 €
VM560/2	160	11	2	HBAA002353	1,379 €	HBAB000130	1,243 €	HDCA000148	64 €	HDEA000145	276 €
VM630/2R	160	15	2	HBAA002395	1,723 €	HBAB000133	1,533 €	HDCA000151	90 €	HDEA000148	276 €
VM630/2	160	18,5	2	HBAA002381	1,723 €	HBAB000132	1,533 €	HDCA000150	90 €	HDEA000147	276 €
VM710/4R	112	4	4	HBAA002569	2,440 €	HBAB000142	2,143 €	HDCA000162	90 €	HDEA000160	174 €
VM710/4	132	5,5	4	HBAA002553	2,440 €	HBAB000141	2,143 €	HDCA000161	90 €	HDEA000159	276 €
VM710/2R	180	22	2	HBAA002425	2,440 €	HBAB000135	2,143 €	HDCA000153	90 €	HDEA000150	276 €
VM710/2	200	30	2	HBAA002409	2,619 €	HBAB000134	2,264 €	HDCA000152	90 €	HDEA000149	368 €
VM800/4R	132	7,5	4	HBAA002601	3,781 €	HBAB000144	3,273 €	HDCA000164	90 €	HDEA000162	276 €
VM800/4	160	11	4	HBAA002585	3,781 €	HBAB000143	3,273 €	HDCA000163	90 €	HDEA000161	276 €
VM800/2R	225	45	2	HBAA002457	3,781 €	HBAB000138	3,731 €	HDCA000155	90 €	HDEA000153	368 €
VM800/2	250	55	2	HBAA002441	3,951 €	HBAB000136	3,731 €	HDCA000154	90 €	HDEA000151	368 €
VM900/4R	160	11	4	HBAA002633	5,103 €	HBAB000146	4,231 €	HDCA000166	90 €	HDEA000164	276 €
VM900/4	160	15	4	HBAA002617	5,103 €	HBAB000145	4,231 €	HDCA000165	90 €	HDEA000163	276 €
VM900/2R	280	75	2	HBAA002489	5,345 €	HBAB000140	4,834 €	HDCA000157	90 €	HDEA000155	431 €
VM900/2	280	90	2	HBAA002473	5,345 €	HBAB000139	4,834 €	HDCA000156	90 €	HDEA000154	431 €
VM1000/4R	180	18,5	4	HBAA002665	7,272 €	HBAB000148	6,236 €	HDCA000168	113 €	HDEA000166	276 €
VM1000/4	180	22	4	HBAA002649	7,272 €	HBAB000147	6,236 €	HDCA000167	113 €	HDEA000165	276 €
VM1000/2R	315	110	2	HBAA002521	7,624 €	N	N	HDCA000159	113 €	HDEA000157	431 €
VM1000/2	315	160	2	HBAA002505	7,624 €	N	N	HDCA000158	113 €	HDEA000156	431 €
VM1120/4	225	22	4	HBAA002681	8,723 €	N	N	HDCA000169	113 €	HDEA000167	431 €
VM1120/2	315	22	2	HBAA002537	10,153 €	N	N	HDCA000160	113 €	HDEA000158	431 €
VM1250/4	280	22	4	HBAA002697	13,215 €	N	N	HDCA000170	113 €	HDEA000168	431 €
VM1400/4	315	22	4	HBAA002713	15,658 €	N	N	HDCA000171	113 €	HDEA000169	487 €

Typ	TEN		DP		WC		FS		Extra 2GD EX.4	
	Code	Preis	Code	Preis	Code	Preis	Code	Preis	Code	Preis
VM350/2R	HGBA000140	111 €	HDDA000141	49 €	HDBA000141	167 €	HDAA000141	84 €	HEDA000140	645 €
VM350/2	HGBA000139	111 €	HDDA000140	49 €	HDBA000140	167 €	HDAA000140	84 €	HEDA000139	645 €
VM400/2R	HGBA000142	174 €	HDDA000143	49 €	HDBA000143	167 €	HDAA000143	85 €	HEDA000142	769 €
VM400/2	HGBA000141	174 €	HDDA000142	49 €	HDBA000142	167 €	HDAA000142	85 €	HEDA000141	769 €
VM450/2R	HGBA000144	174 €	HDDA000145	49 €	HDBA000145	207 €	HDAA000145	92 €	HEDA000144	829 €
VM450/2	HGBA000143	174 €	HDDA000144	49 €	HDBA000144	207 €	HDAA000144	92 €	HEDA000143	829 €
VM500/2R	HGBA000146	174 €	HDDA000147	49 €	HDBA000147	204 €	HDAA000147	102 €	HEDA000146	888 €
VM500/2	HGBA000145	276 €	HDDA000146	49 €	HDBA000146	204 €	HDAA000146	102 €	HEDA000145	990 €
VM560/2R	HGBA000148	276 €	HDDA000149	49 €	HDBA000149	262 €	HDAA000149	108 €	HEDA000148	1,110 €
VM560/2	HGBA000147	276 €	HDDA000148	49 €	HDBA000148	262 €	HDAA000148	108 €	HEDA000147	1,110 €
VM630/2R	HGBA000150	276 €	HDDA000151	49 €	HDBA000151	290 €	HDAA000151	111 €	HEDA000150	1,170 €
VM630/2	HGBA000149	276 €	HDDA000150	49 €	HDBA000150	290 €	HDAA000150	111 €	HEDA000149	724 €
VM710/4R	HGBA000160	174 €	HDDA000162	78 €	HDBA000162	C	HDAA000162	161 €	HEDA000160	791 €
VM710/4	HGBA000159	276 €	HDDA000161	78 €	HDBA000161	C	HDAA000161	161 €	HEDA000159	893 €
VM710/2R	HGBA000152	276 €	HDDA000153	78 €	HDBA000153	C	HDAA000153	161 €	HEDA000152	893 €
VM710/2	HGBA000151	368 €	HDDA000152	78 €	HDBA000152	C	HDAA000152	161 €	HEDA000151	986 €
VM800/4R	HGBA000162	276 €	HDDA000164	78 €	HDBA000164	C	HDAA000164	196 €	HEDA000162	1,056 €
VM800/4	HGBA000161	276 €	HDDA000163	78 €	HDBA000163	C	HDAA000163	196 €	HEDA000161	1,056 €
VM800/2R	HGBA000154	368 €	HDDA000155	78 €	HDBA000155	C	HDAA000155	196 €	HEDA000154	1,148 €
VM800/2	HGBA000153	368 €	HDDA000154	78 €	HDBA000154	C	HDAA000154	196 €	HEDA000153	1,148 €
VM900/4R	HGBA000164	276 €	HDDA000166	78 €	HDBA000166	C	HDAA000166	253 €	HEDA000164	1,109 €
VM900/4	HGBA000163	276 €	HDDA000165	78 €	HDBA000165	C	HDAA000165	253 €	HEDA000163	1,109 €
VM900/2R	HGBA000156	431 €	HDDA000157	78 €	HDBA000157	C	HDAA000157	253 €	HEDA000156	1,264 €
VM900/2	HGBA000155	431 €	HDDA000156	78 €	HDBA000156	C	HDAA000156	253 €	HEDA000155	1,264 €
VM1000/4R	HGBA000166	276 €	HDDA000168	78 €	HDBA000168	C	HDAA000168	266 €	HEDA000166	1,359 €
VM1000/4	HGBA000165	276 €	HDDA000167	78 €	HDBA000167	C	HDAA000167	266 €	HEDA000165	1,359 €
VM1000/2R	HGBA000158	431 €	HDDA000159	78 €	HDBA000159	C	HDAA000159	266 €	HEDA000158	1,515 €
VM1000/2	HGBA000157	431 €	HDDA000158	78 €	HDBA000158	C	HDAA000158	266 €	HEDA000157	1,515 €
VM1120/4	HGBA000167	431 €	HDDA000169	78 €	HDBA000169	C	HDAA000169	C	HEDA000167	1,922 €
VM1120/2	N	N	HDDA000160	78 €	HDBA000160	C	HDAA000160	C	N	N
VM1250/4	HGBA000168	431 €	HDDA000170	78 €	HDBA000170	C	HDAA000170	C	HEDA000168	1,981 €
VM1400/4	HGBA000169	487 €	HDDA000171	78 €	HDBA000171	C	HDAA000171	C	HEDA000169	2,450 €

Typ	Extra 2GD EX.5		Extra 3GD EX.4		Extra 3GD EX.5		Extra Tipo C EX.4		Extra Tipo C EX.5	
	Code	Preis	Code	Preis	Code	Preis	Code	Preis	Code	Preis
VM350/2R	HEDA000543	538 €	HEGA000139	360 €	HEGA000542	378 €	HEAA000141	144 €	HEAA000544	147 €
VM350/2	HEDA000542	538 €	HEGA000138	360 €	HEGA000541	412 €	HEAA000140	144 €	HEAA000543	147 €
VM400/2R	HEDA000545	574 €	HEGA000141	483 €	HEGA000544	445 €	HEAA000143	186 €	HEAA000546	165 €
VM400/2	HEDA000544	574 €	HEGA000140	483 €	HEGA000543	445 €	HEAA000142	186 €	HEAA000545	165 €
VM450/2R	HEDA000547	666 €	HEGA000143	503 €	HEGA000546	466 €	HEAA000145	204 €	HEAA000548	216 €
VM450/2	HEDA000546	666 €	HEGA000142	503 €	HEGA000545	487 €	HEAA000144	204 €	HEAA000547	216 €
VM500/2R	HEDA000549	722 €	HEGA000145	535 €	HEGA000548	508 €	HEAA000147	228 €	HEAA000550	237 €
VM500/2	HEDA000548	742 €	HEGA000144	535 €	HEGA000547	532 €	HEAA000146	228 €	HEAA000549	256 €
VM560/2R	HEDA000551	811 €	HEGA000147	729 €	HEGA000550	578 €	HEAA000149	304 €	HEAA000552	280 €
VM560/2	HEDA000550	834 €	HEGA000146	991 €	HEGA000549	578 €	HEAA000148	304 €	HEAA000551	304 €
VM630/2R	HEDA000553	895 €	HEGA000149	1,051 €	HEGA000552	659 €	HEAA000151	311 €	HEAA000554	311 €
VM630/2	HEDA000552	895 €	HEGA000148	1,051 €	HEGA000551	696 €	HEAA000150	311 €	HEAA000553	311 €
VM710/4R	HEDA000558	571 €	HEGA000159	774 €	HEGA000557	693 €	HEAA000161	321 €	HEAA000559	274 €
VM710/4	HEDA000557	591 €	HEGA000158	774 €	HEGA000556	634 €	HEAA000160	321 €	HEAA000558	294 €
VM710/2R	HEDA000555	615 €	HEGA000151	774 €	HEGA000554	578 €	HEAA000153	321 €	HEAA000556	318 €
VM710/2	HEDA000554	637 €	HEGA000150	867 €	HEGA000553	729 €	HEAA000152	321 €	HEAA000555	340 €
VM800/4R	HEDA000560	664 €	HEGA000161	1,029 €	HEGA000559	879 €	HEAA000163	465 €	HEAA000561	349 €
VM800/4	HEDA000559	687 €	HEGA000160	1,029 €	HEGA000558	668 €	HEAA000162	465 €	HEAA000560	372 €
VM800/2R	HEDA000556	710 €	HEGA000153	1,029 €	HEGA000555	634 €	HEAA000155	465 €	HEAA000557	395 €
VM800/2	N	N	HEGA000152	1,029 €	N	N	HEAA000154	465 €	N	N
VM900/4R	HEDA000562	732 €	HEGA000163	990 €	HEGA000561	372 €	HEAA000165	514 €	HEAA000563	413 €
VM900/4	HEDA000561	732 €	HEGA000162	990 €	HEGA000560	843 €	HEAA000164	514 €	HEAA000562	413 €
VM900/2R	N	N	HEGA000155	1,145 €	N	N	HEAA000157	514 €	N	N
VM900/2	N	N	HEGA000154	1,145 €	N	N	HEAA000156	514 €	N	N
VM1000/4R	N	N	HEGA000165	1,219 €	N	N	HEAA000167	687 €	N	N
VM1000/4	N	N	HEGA000164	1,219 €	N	N	HEAA000166	687 €	N	N
VM1000/2R	N	N	HEGA000157	1,375 €	N	N	HEAA000159	687 €	N	N
VM1000/2	N	N	HEGA000156	1,375 €	N	N	HEAA000158	687 €	N	N
VM1120/4	N	N	HEGA000166	1,782 €	N	N	HEAA000168	1,089 €	N	N
VM1120/2	N	N	N	N	N	N	N	N	N	N
VM1250/4	N	N	HEGA000167	1,841 €	N	N	HEAA000169	1,147 €	N	N
VM1400/4	N	N	HEGA000168	2,310 €	N	N	HEAA000170	1,527 €	N	N

VG/N - Ventilatoren

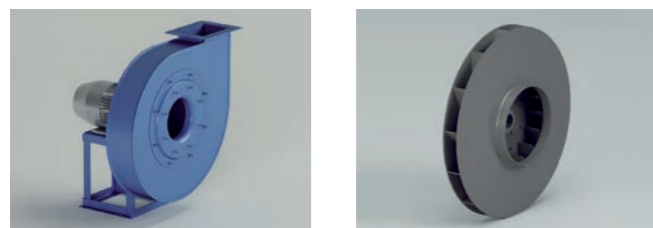

• **Arbeitsbereich :**
Niedrige - mittlere Fördermengen. Hohe Drücke

• **Laufrad :**
rückwärts gekrümmt, geschlossen.

Anwendungen :
Zum Transport von Stäuben, zur Trocknung und für mit Überdruck zu beaufschlagende Räume. Zur Verwendung im industriellen Bereich, Giessereien, Nudelfabriken, Öfen und der Chemie geeignet.

Technische Spezifikationen :
Luftvolumen : 300 bis 32.000 m³/h.
Gesamtdruck : 75 bis 2.200 daPa.

Ventilator	Max-Umdrehungen (rpm)			
	Größe	KLASSE I	KLASSE II	KLASSE III
VG400	5000	-	-	-
VG450/R	5000	-	-	-
VG450	5000	-	-	-
VG500/R	4750	-	-	-
VG500	4500	5000	-	-
VG560/R	4250	4750	-	-
VG560	4000	4500	-	-
VG630/R	3850	4150	4500	-
VG630	3700	3900	4250	-
VG710/R	3550	3850	4150	-
VG710	3400	3700	4000	-

Ventilator	Max-Umdrehungen (rpm)			
	Größe	KLASSE I	KLASSE II	KLASSE III
VG800/R	3250	3550	3850	-
VG800	3000	3300	3600	-
VG900/R	3250	3500	3700	-
VG900	3000	3250	3450	-
VG1000/R	3150	3350	3450	-
VG1000	3000	3150	3350	-
VG1120	2700	2900	3100	-
VG1250	2400	2600	2800	-
VG1400	2100	2300	2450	-
VG1600	1850	2000	2100	-

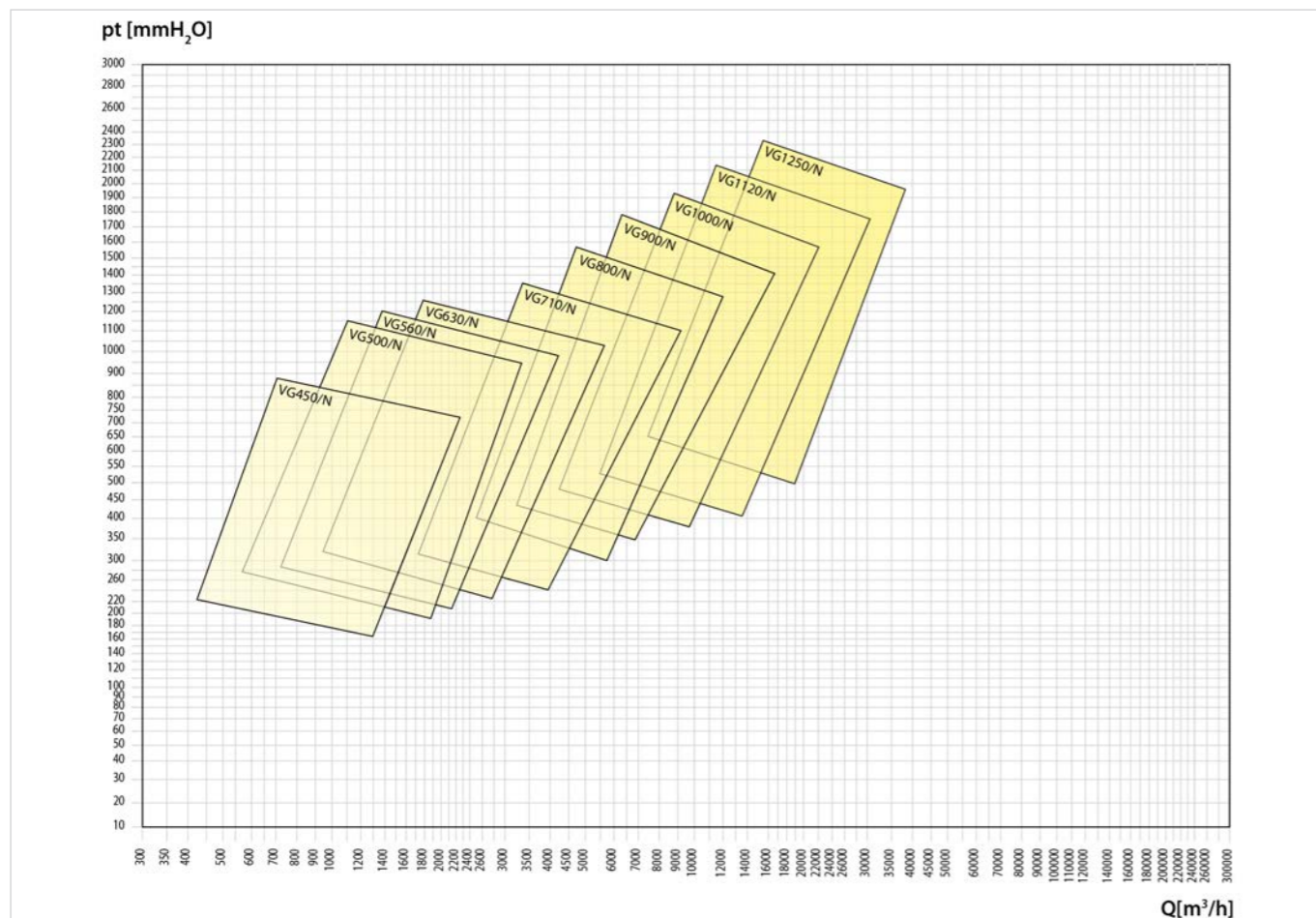

Typ	Gr	kW	Pole	EX4		EX5		ID		HT	
				Code	Preis	Code	Preis	Code	Preis	Code	Preis
VGN400/2	90	1,5	2	HBAA004839	763 €	HBAB000282	699 €	HDCA000301	57 €	HDEA000307	174 €
VGN450/2	90	2,2	2	HBAA004853	972 €	HBAB000283	882 €	HDCA000302	57 €	HDEA000308	174 €
VGN500/2R	100	3	2	HBAA004881	1,124 €	HBAB000285	1,018 €	HDCA000304	64 €	HDEA000310	174 €
VGN500/2	112	4	2	HBAA004867	1,124 €	HBAB000284	1,018 €	HDCA000303	64 €	HDEA000309	174 €
VGN560/2R	132	5,5	2	HBAA004909	1,460 €	HBAB000287	1,375 €	HDCA000306	64 €	HDEA000312	276 €
VGN560/2	132	7,5	2	HBAA004895	1,460 €	HBAB000286	1,375 €	HDCA000305	64 €	HDEA000311	276 €
VGN630/2R	160	11	2	HBAA004937	1,813 €	HBAB000289	1,680 €	HDCA000308	90 €	HDEA000314	276 €
VGN630/2	160	11	2	HBAA004923	1,813 €	HBAB000288	1,680 €	HDCA000307	90 €	HDEA000313	276 €
VGN710/2R	160	18,5	2	HBAA004983	2,400 €	HBAB000292	2,204 €	HDCA000311	90 €	HDEA000317	276 €
VGN710/2	180	22	2	HBAA004951	2,400 €	HBAB000290	2,204 €	HDCA000309	90 €	HDEA000315	276 €
VGN800/2R	200	30	2	HBAA005031	3,776 €	HBAB000294	3,919 €	HDCA000313	90 €	HDEA000319	368 €
VGN800/2	200	37	2	HBAA004999	3,776 €	HBAB000293	3,919 €	HDCA000312	90 €	HDEA000318	368 €
VGN900/2R	225	45	2	HBAA005063	5,251 €	HBAB000296	5,040 €	HDCA000315	90 €	HDEA000322	368 €
VGN900/2	250	55	2	HBAA005047	5,251 €	HBAB000295	5,040 €	HDCA000314	90 €	HDEA000320	368 €
VGN1000/2R	280	90	2	HBAA005095	7,375 €	N	N	HDCA000317	113 €	HDEA000324	431 €
VGN1000/2	315	110	2	HBAA005079	7,375 €	N	N	HDCA000316	113 €	HDEA000323	431 €
VGN1120/4	225	132	4	HBAA005127	8,308 €	N	N	HDCA000319	113 €	HDEA000326	431 €
VGN1120/2	315	132	2	HBAA005111	9,727 €	N	N	HDCA000318	113 €	HDEA000325	431 €
VGN1250/4	250	132	4	HBAA005143	12,586 €	N	N	HDCA000320	113 €	HDEA000327	431 €
VGN1400/4	280	132	4	HBAA005159	14,343 €	N	N	HDCA000321	113 €	HDEA000328	487 €
VGN1600/4	315	132	4	HBAA005175	20,517 €	N	N	HDCA000322	113 €	HDEA000329	487 €

Typ	TEN		DP		WC		FS		Extra 2GD EX.4	
	Code	Preis	Code	Preis	Code	Preis	Code	Preis	Code	Preis
VGN400/2	HGBA000309	174 €	HDDA000301	49 €	HDBA000303	167 €	HDAA000302	85 €	HEDA000300	769 €
VGN450/2	HGBA000310	174 €	HDDA000302	49 €	HDBA000304	207 €	HDAA000303	92 €	HEDA000301	829 €
VGN500/2R	HGBA000312	174 €	HDDA000304	49 €	HDBA000306	234 €	HDAA000305	102 €	HEDA000303	888 €
VGN500/2	HGBA000311	174 €	HDDA000303	49 €	HDBA000305	234 €	HDAA000304	102 €	HEDA000302	888 €
VGN560/2R	HGBA000314	276 €	HDDA000306	49 €	HDBA000308	262 €	HDAA000307	108 €	HEDA000305	1,110 €
VGN560/2	HGBA000313	276 €	HDDA000305	49 €	HDBA000307	262 €	HDAA000306	108 €	HEDA000304	1,110 €
VGN630/2R	HGBA000316	276 €	HDDA000308	49 €	HDBA000310	290 €	HDAA000309	111 €	HEDA000307	1,170 €
VGN630/2	HGBA000315	276 €	HDDA000307	49 €	HDBA000309	290 €	HDAA000308	111 €	HEDA000306	1,170 €
VGN710/2R	HGBA000319	276 €	HDDA000311	78 €	HDBA000313	C	HDAA000312	161 €	HEDA000309	893 €
VGN710/2	HGBA000317	276 €	HDDA000309	78 €	HDBA000311	C	HDAA000310	161 €	HEDA000308	893 €
VGN800/2R	HGBA000321	368 €	HDDA000313	78 €	HDBA000315	C	HDAA000314	196 €	HEDA000311	1,148 €
VGN800/2	HGBA000320	368 €	HDDA000312	78 €	HDBA000314	C	HDAA000313	196 €	HEDA000310	724 €
VGN900/2R	HGBA000324	368 €	HDDA000315	78 €	HDBA000317	C	HDAA000316	253 €	HEDA000313	1,201 €
VGN900/2	HGBA000322	368 €	HDDA000314	78 €	HDBA000316	C	HDAA000315	253 €	HEDA000312	1,201 €
VGN1000/2R	HGBA000326	431 €	HDDA000317	78 €	HDBA000319	C	HDAA000318	266 €	HEDA000315	1,515 €
VGN1000/2	HGBA000325	431 €	HDDA000316	78 €	HDBA000318	C	HDAA000317	266 €	HEDA000314	1,515 €
VGN1120/4	HGBA000328	431 €	HDDA000319	78 €	HDBA000321	C	HDAA000320	C	HEDA000316	1,922 €
VGN1120/2	HGBA000327	431 €	HDDA000318	78 €	HDBA000320	C	HDAA000319	C	N	N
VGN1250/4	HGBA000329	431 €	HDDA000320	78 €	HDBA000322	C	HDAA000321	C	HEDA000317	1,981 €
VGN1400/4	HGBA000330	487 €	HDDA000321	78 €	HDBA000323	C	HDAA000322	C	HEDA000318	2,450 €
VGN1600/4	HGBA000331	487 €	HDDA000322	78 €	HDBA000324	C	HDAA000323	C	HEDA000319	2,720 €

Typ	Extra 2GD EX.5		Extra 3GD EX.4		Extra 3GD EX.5		Extra Tipo C EX.4		Extra Tipo C EX.5	
	Code	Preis	Code	Preis	Code	Preis	Code	Preis	Code	Preis
VGN400/2	HEDA000669	634 €	HEGA000299	503 €	HEGA000667	402 €	HEAA000301	204 €	HEAA000672	183 €
VGN450/2	HEDA000671	722 €	HEGA000301	535 €	HEGA000669	469 €	HEAA000303	228 €	HEAA000674	237 €
VGN500/2R	HEDA000670	722 €	HEGA000300	535 €	HEGA000668	402 €	HEAA000302	228 €	HEAA000673	237 €
VGN500/2	HEDA000673	811 €	HEGA000303	729 €	HEGA000671	497 €	HEAA000305	304 €	HEAA000676	280 €
VGN560/2R	HEDA000672	811 €	HEGA000302	729 €	HEGA000670	445 €	HEAA000304	304 €	HEAA000675	280 €
VGN560/2	HEDA000675	895 €	HEGA000305	1,051 €	HEGA000673	603 €	HEAA000307	311 €	HEAA000678	311 €
VGN630/2R	HEDA000674	895 €	HEGA000304	1,051 €	HEGA000672	497 €	HEAA000306	311 €	HEAA000677	311 €
VGN630/2	HEDA000677	615 €	HEGA000307	774 €	HEGA000675	246 €	HEAA000309	321 €	HEAA000680	318 €
VGN710/2R	HEDA000676	615 €	HEGA000306	774 €	HEGA000674	603 €	HEAA000308	321 €	HEAA000679	318 €
VGN710/2	HEDA000679	710 €	HEGA000309	1,029 €	HEGA000677	281 €	HEAA000311	465 €	HEAA000682	395 €
VGN800/2R	HEDA000678	710 €	HEGA000308	1,029 €	HEGA000676	260 €	HEAA000310	465 €	HEAA000681	395 €
VGN800/2	N	N	HEGA000311	1,082 €	N	N	HEAA000313	514 €	N	N
VGN900/2R	N	N	HEGA000310	1,082 €	N	N	HEAA000312	514 €	N	N
VGN900/2	N	N	HEGA000313	1,375 €	N	N	HEAA000315	687 €	N	N
VGN1000/2R	N	N	HEGA000312	1,375 €	N	N	HEAA000314	687 €	N	N
VGN1000/2	N	N	HEGA000314	1,782 €	N	N	HEAA000316	1,089 €	N	N
VGN1120/4	N	N	N	N	N	N	N	N	N	N
VGN1120/2	N	N	HEGA000315	1,841 €	N	N	HEAA000317	1,147 €	N	N
VGN1250/4	N	N	HEGA000316	2,310 €	N	N	HEAA000318	1,527 €	N	N
VGN1400/4	N	N	HEGA000317	2,580 €	N	N	HEAA000319	1,795 €	N	N
VGN1600/4	N	N	HEGA000317	2.580 €	N	N	HEAA000319	1.795 €	N	N

VP/N - Ventilatoren



Arbeitsbereich :
Niedrige - mittlere Fördermengen. Hohe Drücke.
Schaufelform :
Kurve, rückwärts gekrümmt mit Deckel.
Anwendungen :
Zum Transport von Stäuben, zur Trocknung und für mit Überdruck zu beaufschlagende Räume. Zur Verwendung im industriellen Bereich, Giessereien, Nudelfabriken, Öfen und der Chemie geeignet.
Technische Spezifikationen :
Luftvolumen : 140 bis 22.000 m³/h.
Gesamtdruck : 100 bis 3.000 daPa.

Ventilator	Max-Umdrehungen (rpm)		
	Größe	KLASSE I	KLASSE II
VP400	5000	-	-
VP450/R	5000	-	-
VP450	5000	-	-
VP500	5000	-	-
VP560/R	5000	-	-
VP560	4700	5000	-
VP630/R	4400	4850	-
VP630	4100	4550	5000
VP710/R	3700	4100	4500
VP710	3550	3850	4250
VP800/R	3400	3700	4000

Ventilator	Max-Umdrehungen (rpm)		
	Größe	KLASSE I	KLASSE II
VP800	3250	3550	3850
VP900/R	3100	3400	3700
VP900	2960	3250	3550
VP1000/R	3100	3550	3850
VP1000	3300	3550	3900
VP1120/R	3200	3450	3700
VP1120	3000	3250	3500
VP1250	2650	2800	3000
VP1400	2350	2500	2650
VP1600	2000	2150	2300

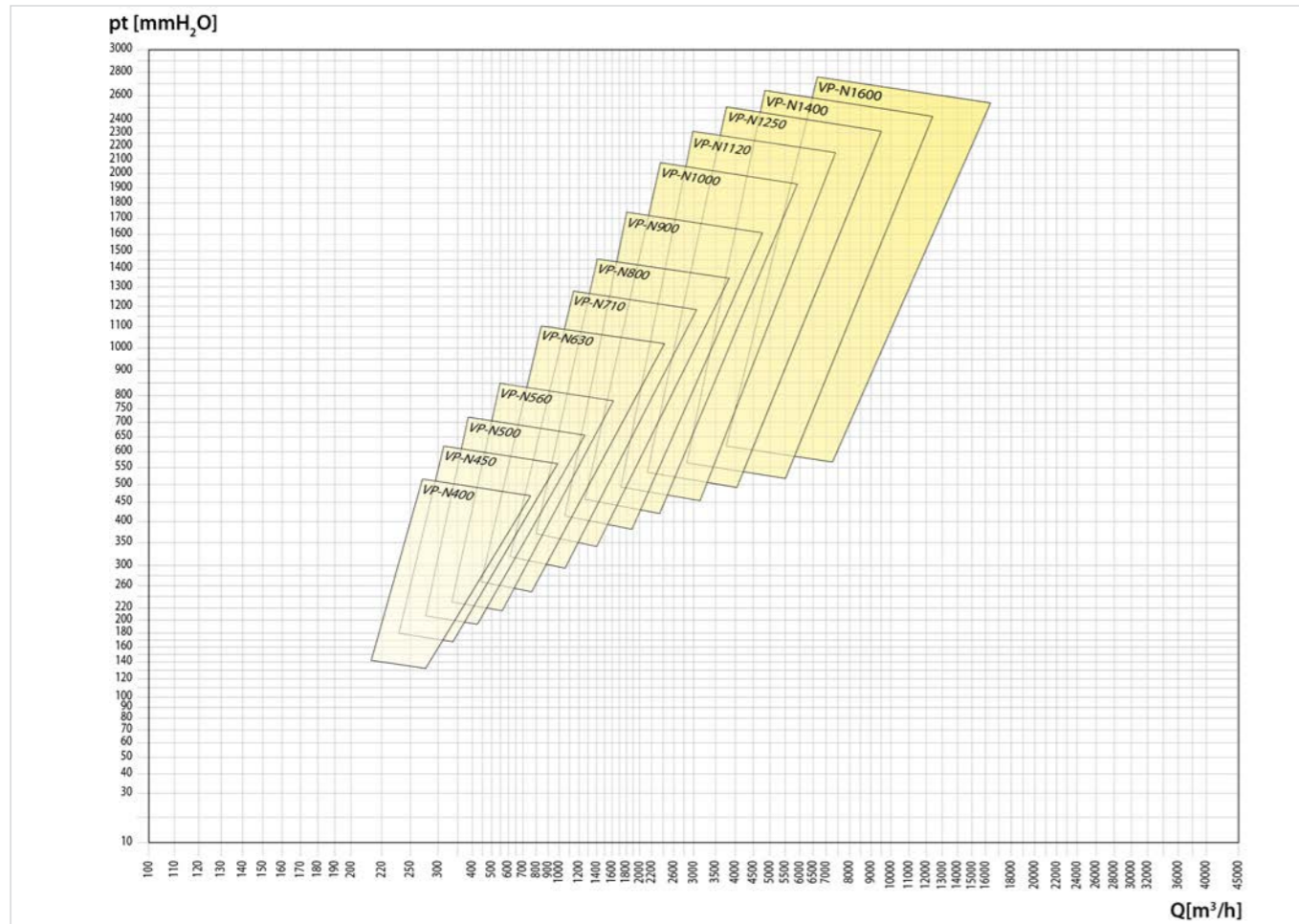

Typ	Gr	kW	Pole	EX4		EX5		ID		HT	
				Code	Preis	Code	Preis	Code	Preis	Code	Preis
VPN400/2	71	0,55	2	HBAA004087	781 €	HBAB000239	717 €	HDCA000256	57 €	HDEA000255	111 €
VPN450/2	80	1,1	2	HBAA004101	904 €	HBAB000240	815 €	HDCA000257	57 €	HDEA000256	111 €
VPN500/2R	90	1,5	2	HBAA004129	1,119 €	HBAB000242	1,012 €	HDCA000259	64 €	HDEA000258	174 €
VPN500/2	90	2,2	2	HBAA004115	1,119 €	HBAB000241	1,012 €	HDCA000258	64 €	HDEA000257	174 €
VPN560/2R	90	2,2	2	HBAA004157	1,464 €	HBAB000244	1,379 €	HDCA000261	64 €	HDEA000260	174 €
VPN560/2	100	3	2	HBAA004143	1,464 €	HBAB000243	1,379 €	HDCA000260	64 €	HDEA000259	174 €
VPN630/2R	112	4	2	HBAA004185	1,858 €	HBAB000246	1,725 €	HDCA000263	90 €	HDEA000262	276 €
VPN630/2	132	5,5	2	HBAA004171	1,858 €	HBAB000245	1,725 €	HDCA000262	90 €	HDEA000261	276 €
VPN710/2R	132	7,5	2	HBAA004215	2,209 €	HBAB000248	2,013 €	HDCA000265	90 €	HDEA000265	276 €
VPN710/2	160	11	2	HBAA004199	2,209 €	HBAB000247	2,013 €	HDCA000264	90 €	HDEA000264	276 €
VPN800/2R	160	15	2	HBAA004247	2,834 €	HBAB000250	2,519 €	HDCA000267	90 €	HDEA000267	276 €
VPN800/2	160	18,5	2	HBAA004231	2,834 €	HBAB000249	2,519 €	HDCA000266	90 €	HDEA000266	276 €
VPN900/2R	180	22	2	HBAA004279	3,711 €	HBAB000252	3,126 €	HDCA000269	90 €	HDEA000269	276 €
VPN900/2	200	30	2	HBAA004263	3,711 €	HBAB000251	3,730 €	HDCA000268	90 €	HDEA000268	368 €
VPN1000/2R	225	45	2	HBAA004311	5,265 €	HBAB000255	4,659 €	HDCA000271	113 €	HDEA000272	368 €
VPN1000/2	250	55	2	HBAA004295	5,265 €	HBAB000253	4,659 €	HDCA000270	113 €	HDEA000270	368 €
VPN1120/2R	280	75	2	HBAA004343	8,273 €	N	N	HDCA000273	113 €	HDEA000274	431 €
VPN1120/2	280	90	2	HBAA004327	8,273 €	N	N	HDCA000272	113 €	HDEA000273	431 €
VPN1250/2	315	110	2	HBAA004359	12,027 €	N	N	HDCA000274	113 €	HDEA000275	431 €
VPN1400/4	225	110	4	HBAA004375	12,027 €	N	N	HDCA000275	113 €	HDEA000276	487 €

Typ	TEN		DP		WC		FS		Extra 2GD EX.4	
	Code	Preis	Code	Preis	Code	Preis	Code	Preis	Code	Preis
VPN400/2	HGBA000257	111 €	HDDA000256	49 €	HDBA000256	167 €	HDAA000254	85 €	HEDA000255	676 €
VPN450/2	HGBA000258	111 €	HDDA000257	49 €	HDBA000257	207 €	HDAA000255	92 €	HEDA000256	729 €
VPN500/2R	HGBA000261	174 €	HDDA000259	49 €	HDBA000259	234 €	HDAA000257	102 €	HEDA000258	832 €
VPN500/2	HGBA000260	174 €	HDDA000258	49 €	HDBA000258	234 €	HDAA000256	102 €	HEDA000257	832 €
VPN560/2R	HGBA000263	174 €	HDDA000261	49 €	HDBA000261	262 €	HDAA000259	108 €	HEDA000260	949 €
VPN560/2	HGBA000262	174 €	HDDA000260	49 €	HDBA000260	262 €	HDAA000258	108 €	HEDA000259	949 €
VPN630/2R	HGBA000265	174 €	HDDA000263	49 €	HDBA000263	C	HDAA000261	111 €	HEDA000262	731 €
VPN630/2	HGBA000264	276 €	HDDA000262	49 €	HDBA000262	C	HDAA000260	111 €	HEDA000261	833 €
VPN710/2R	HGBA000267	276 €	HDDA000265	78 €	HDBA000265	C	HDAA000263	161 €	HEDA000264	861 €
VPN710/2	HGBA000266	276 €	HDDA000264	78 €	HDBA000264	C	HDAA000262	161 €	HEDA000263	861 €
VPN800/2R	HGBA000269	276 €	HDDA000267	78 €	HDBA000267	C	HDAA000265	196 €	HEDA000266	1,000 €
VPN800/2	HGBA000268	276 €	HDDA000266	78 €	HDBA000266	C	HDAA000264	196 €	HEDA000265	724 €
VPN900/2R	HGBA000271	368 €	HDDA000269	78 €	HDBA000269	C	HDAA000267	253 €	HEDA000268	1,025 €
VPN900/2	HGBA000270	368 €	HDDA000268	78 €	HDBA000268	C	HDAA000266	253 €	HEDA000267	1,117 €
VPN1000/2R	HGBA000275	368 €	HDDA000271	78 €	HDBA000272	C	HDAA000270	266 €	HEDA000270	1,361 €
VPN1000/2	HGBA000273	368 €	HDDA000270	78 €	HDBA000270	C	HDAA000268	266 €	HEDA000269	1,361 €
VPN1120/2R	HGBA000277	431 €	HDDA000273	78 €	HDBA000274	C	HDAA000272	281 €	HEDA000272	1,877 €
VPN1120/2	HGBA000276	431 €	HDDA000272	78 €	HDBA000273	C	HDAA000271	281 €	HEDA000271	1,877 €
VPN1250/2	HGBA000278	431 €	HDDA000274	78 €	HDBA000275	C	HDAA000273	C	HEDA000273	1,924 €
VPN1400/4	HGBA000279	487 €	HDDA000275	78 €	HDBA000276	C	HDAA000274	C	HEDA000274	2,381 €

Typ	Extra 2GD EX.5		Extra 3GD EX.4		Extra 3GD EX.5		Extra Tipo C EX.4		Extra Tipo C EX.5	
	Code	Preis	Code	Preis	Code	Preis	Code	Preis	Code	Preis
VPN400/2	HEDA000632	545 €	HEGA000253	391 €	HEGA000630	545 €	HEAA000255	157 €	HEAA000635	136 €
VPN450/2	HEDA000633	598 €	HEGA000254	403 €	HEGA000631	613 €	HEAA000256	168 €	HEAA000636	147 €
VPN500/2R	HEDA000635	634 €	HEGA000256	479 €	HEGA000633	683 €	HEAA000258	172 €	HEAA000638	148 €
VPN500/2	HEDA000634	634 €	HEGA000255	479 €	HEGA000632	613 €	HEAA000257	172 €	HEAA000637	148 €
VPN560/2R	HEDA000637	700 €	HEGA000258	568 €	HEGA000635	354 €	HEAA000260	245 €	HEAA000640	169 €
VPN560/2	HEDA000636	732 €	HEGA000257	568 €	HEGA000634	683 €	HEAA000259	245 €	HEAA000639	202 €
VPN630/2R	HEDA000639	514 €	HEGA000260	612 €	HEGA000637	598 €	HEAA000262	263 €	HEAA000642	220 €
VPN630/2	HEDA000638	533 €	HEGA000259	714 €	HEGA000636	333 €	HEAA000261	263 €	HEAA000641	239 €
VPN710/2R	HEDA000641	559 €	HEGA000262	742 €	HEGA000639	629 €	HEAA000264	288 €	HEAA000644	262 €
VPN710/2	HEDA000640	582 €	HEGA000261	742 €	HEGA000638	367 €	HEAA000263	288 €	HEAA000643	286 €
VPN800/2R	HEDA000643	631 €	HEGA000264	881 €	HEGA000641	743 €	HEAA000266	409 €	HEAA000646	316 €
VPN800/2	HEDA000642	631 €	HEGA000263	881 €	HEGA000640	629 €	HEAA000265	409 €	HEAA000645	316 €
VPN900/2R	HEDA000645	648 €	HEGA000266	906 €	HEGA000643	412 €	HEAA000268	430 €	HEAA000648	329 €
VPN900/2	HEDA000644	671 €	HEGA000265	998 €	HEGA000642	718 €	HEAA000267	430 €	HEAA000647	351 €
VPN1000/2R	HEDA000647	790 €	HEGA000268	1,221 €	HEGA000645	466 €	HEAA000270	596 €	HEAA000650	393 €
VPN1000/2	HEDA000646	790 €	HEGA000267	1,221 €	HEGA000644	466 €	HEAA000269	596 €	HEAA000649	393 €
VPN1120/2R	N	N	HEGA000270	1,737 €	N	N	HEAA000272	1,044 €	N	N
VPN1120/2	N	N	HEGA000269	1,737 €	N	N	HEAA000271	1,044 €	N	N
VPN1250/2	N	N	HEGA000271	1,784 €	N	N	HEAA000273	1,147 €	N	N
VPN1400/4	N	N	HEGA000272	2,241 €	N	N	HEAA000274	1,527 €	N	N

VC/N - Ventilatoren

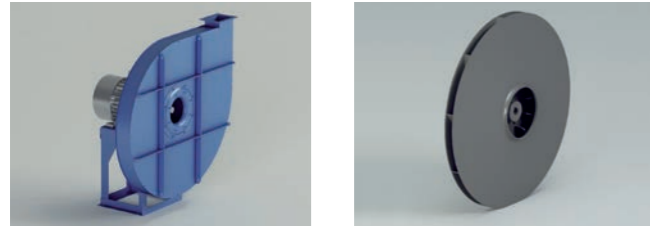

• **Arbeitsbereich :**
Niedrige - mittlere Fördermengen. Hohe Drücke

• **Laufrad :**
rückwärts gekrümmt, geschlossen.

Anwendungen :
Zum Transport von Stäuben, zur Trocknung und für mit Überdruck zu beaufschlagende Räume. Zur Verwendung im industriellen Bereich, Giessereien, Nudelfabriken, Öfen und der Chemie geeignet.

Technische Spezifikationen :
Luftvolumen : 150 bis 10.000 m³/h.
Gesamtdruck : 160 bis 2.850 daPa.

Ventilator	Max-Umdrehungen (rpm)			
	Größe	KLASSE I	KLASSE II	KLASSE III
VC500	5000	-	-	-
VC560/R	5000	-	-	-
VC560	4700	5000	-	-
VC630/R	4400	4850	-	-
VC630	4100	4550	5000	-
VC710/R	3700	4100	4500	-
VC710	3550	3850	4250	-
VC800/R	3400	3700	4000	-

Ventilator	Max-Umdrehungen (rpm)			
	Größe	KLASSE I	KLASSE II	KLASSE III
VC800	3250	3550	3850	-
VC900/R	3100	3400	3700	-
VC900	2960	3250	3550	-
VC1000/R	3100	3550	3850	-
VC1000	3300	3550	3900	-
VC1120/R	3200	3450	3700	-
VC1120	3000	3250	3500	-
VC1250	2650	2800	3000	-

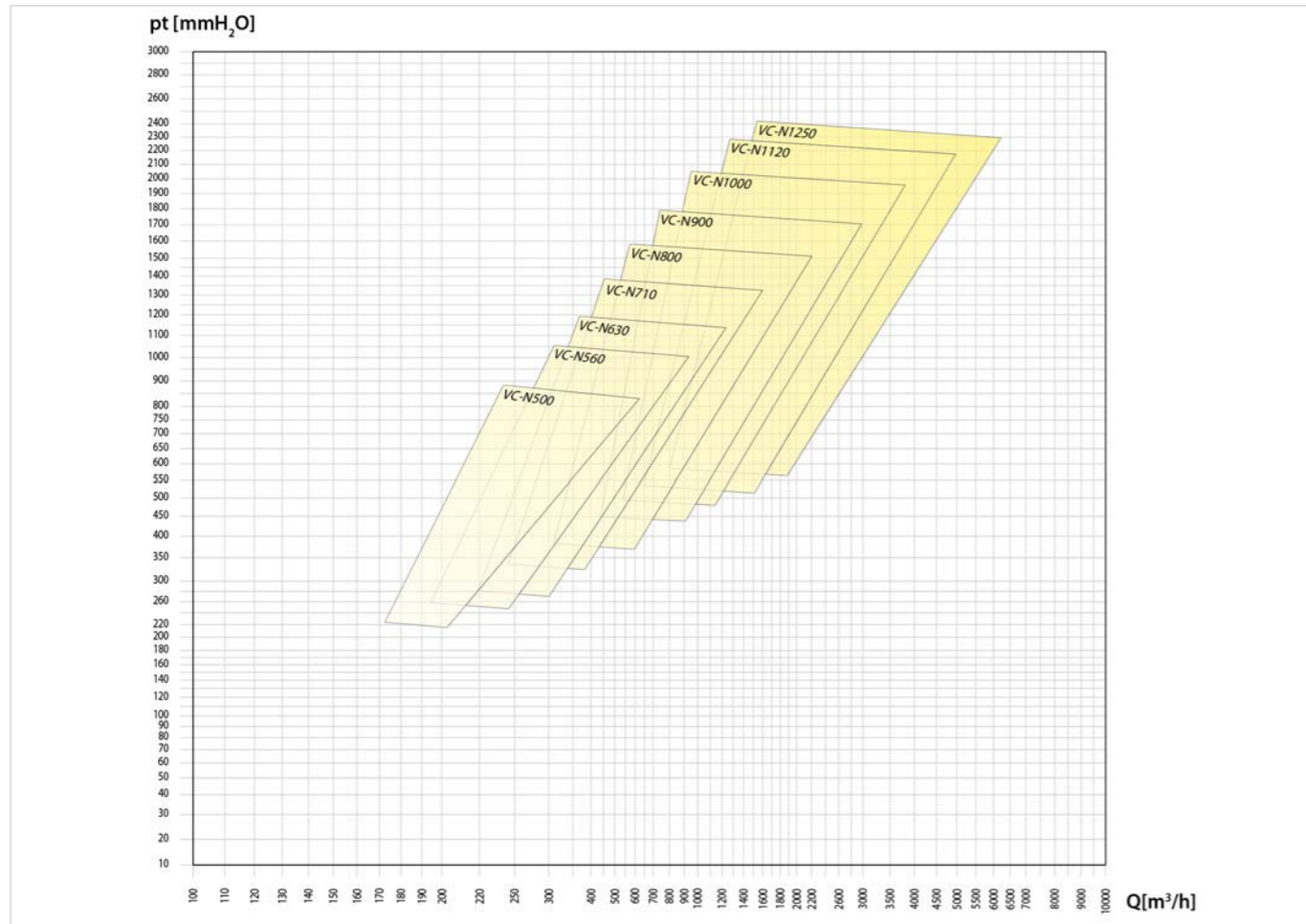

Typ	Gr	kW	Pole	EX4		EX5		ID		HT	
				Code	Preis	Code	Preis	Code	Preis	Code	Preis
VCN500/2R	80	1,1	2	HBAA006089	1,200 €	HBAB000346	1,093 €	HDCA000379	64 €	HDEA000389	111 €
VCN500/2	90	1,5	2	HBAA006075	1,200 €	HBAB000345	1,093 €	HDCA000378	64 €	HDEA000388	111 €
VCN560/2R	90	1,5	2	HBAA006117	1,488 €	HBAB000348	1,403 €	HDCA000381	64 €	HDEA000391	174 €
VCN560/2	90	2,2	2	HBAA006103	1,488 €	HBAB000347	1,403 €	HDCA000380	64 €	HDEA000390	174 €
VCN630/2R	100	3	2	HBAA006145	1,884 €	HBAB000350	1,751 €	HDCA000383	90 €	HDEA000394	174 €
VCN630/2	112	4	2	HBAA006131	1,884 €	HBAB000349	1,751 €	HDCA000382	90 €	HDEA000392	174 €
VCN710/2R	132	5,5	2	HBAA006175	2,226 €	HBAB000352	2,030 €	HDCA000385	90 €	HDEA000396	276 €
VCN710/2	132	7,5	2	HBAA006159	2,226 €	HBAB000351	2,030 €	HDCA000384	90 €	HDEA000395	276 €
VCN800/2R	132	7,5	2	HBAA006207	2,871 €	HBAB000354	2,556 €	HDCA000387	90 €	HDEA000398	276 €
VCN800/2	160	11	2	HBAA006191	2,871 €	HBAB000353	2,556 €	HDCA000386	90 €	HDEA000397	276 €
VCN900/2R	160	15	2	HBAA006239	3,655 €	HBAB000356	3,070 €	HDCA000389	90 €	HDEA000400	276 €
VCN900/2	160	18,5	2	HBAA006223	3,655 €	HBAB000355	3,070 €	HDCA000388	90 €	HDEA000399	276 €
VCN1000/2R	200	30	2	HBAA006271	5,033 €	HBAB000358	4,427 €	HDCA000391	113 €	HDEA000402	368 €
VCN1000/2	200	37	2	HBAA006255	5,033 €	HBAB000357	4,427 €	HDCA000390	113 €	HDEA000401	368 €
VCN1120/2R	225	45	2	HBAA006319	7,190 €	N	N	HDCA000393	113 €	HDEA000405	368 €
VCN1120/2	250	55	2	HBAA006287	7,190 €	N	N	HDCA000392	113 €	HDEA000403	368 €

Typ	TEN		DP		WC		FS		Extra 2GD EX.4	
	Code	Preis	Code	Preis	Code	Preis	Code	Preis	Code	Preis
VCN500/2R	HGBA000390	111 €	HDDA000379	49 €	HDBA000381	234 €	HDAA000380	102 €	HEDA000375	757 €
VCN500/2	HGBA000389	111 €	HDDA000378	49 €	HDBA000380	234 €	HDAA000379	102 €	HEDA000374	757 €
VCN560/2R	HGBA000392	174 €	HDDA000381	49 €	HDBA000383	262 €	HDAA000382	108 €	HEDA000377	930 €
VCN560/2	HGBA000391	174 €	HDDA000380	49 €	HDBA000382	262 €	HDAA000381	108 €	HEDA000376	930 €
VCN630/2R	HGBA000395	174 €	HDDA000383	49 €	HDBA000385	C	HDAA000384	111 €	HEDA000379	693 €
VCN630/2	HGBA000393	174 €	HDDA000382	49 €	HDBA000384	C	HDAA000383	111 €	HEDA000378	693 €
VCN710/2R	HGBA000397	276 €	HDDA000385	78 €	HDBA000387	C	HDAA000386	161 €	HEDA000381	823 €
VCN710/2	HGBA000396	276 €	HDDA000384	78 €	HDBA000386	C	HDAA000385	161 €	HEDA000380	823 €
VCN800/2R	HGBA000399	276 €	HDDA000387	78 €	HDBA000389	C	HDAA000388	196 €	HEDA000383	956 €
VCN800/2	HGBA000398	276 €	HDDA000386	78 €	HDBA000388	C	HDAA000387	196 €	HEDA000382	956 €
VCN900/2R	HGBA000401	276 €	HDDA000389	78 €	HDBA000391	C	HDAA000390	253 €	HEDA000385	993 €
VCN900/2	HGBA000400	276 €	HDDA000388	78 €	HDBA000390	C	HDAA000389	253 €	HEDA000384	724 €
VCN1000/2R	HGBA000403	368 €	HDDA000391	78 €	HDBA000393	C	HDAA000392	266 €	HEDA000387	1,350 €
VCN1000/2	HGBA000402	368 €	HDDA000390	78 €	HDBA000392	C	HDAA000391	266 €	HEDA000386	1,350 €
VCN1120/2R	HGBA000405	368 €	HDDA000393	78 €	HDBA000395	C	HDAA000394	281 €	HEDA000389	1,761 €
VCN1120/2	HGBA000404	368 €	HDDA000392	78 €	HDBA000394	C	HDAA000393	281 €	HEDA000388	1,761 €

Typ	Extra 2GD EX.5		Extra 3GD EX.4		Extra 3GD EX.5		Extra Tipo C EX.4		Extra Tipo C EX.5	
	Code	Preis	Code	Preis	Code	Preis	Code	Preis	Code	Preis
VCN500/2R	HEDA000722	623 €	HEGA000373	405 €	HEGA000720	277 €	HEAA000375	161 €	HEAA000729	137 €
VCN500/2	HEDA000721	623 €	HEGA000372	405 €	HEGA000719	277 €	HEAA000374	161 €	HEAA000728	137 €
VCN560/2R	HEDA000724	680 €	HEGA000375	549 €	HEGA000722	309 €	HEAA000377	225 €	HEAA000731	150 €
VCN560/2	HEDA000723	680 €	HEGA000374	549 €	HEGA000721	309 €	HEAA000376	225 €	HEAA000730	150 €
VCN630/2R	HEDA000726	476 €	HEGA000377	574 €	HEGA000724	365 €	HEAA000379	225 €	HEAA000733	182 €
VCN630/2	HEDA000725	476 €	HEGA000376	574 €	HEGA000723	365 €	HEAA000378	225 €	HEAA000732	182 €
VCN710/2R	HEDA000728	521 €	HEGA000379	704 €	HEGA000726	413 €	HEAA000381	251 €	HEAA000735	224 €
VCN710/2	HEDA000727	521 €	HEGA000378	704 €	HEGA000725	413 €	HEAA000380	251 €	HEAA000734	224 €
VCN800/2R	HEDA000730	564 €	HEGA000381	837 €	HEGA000728	462 €	HEAA000383	365 €	HEAA000737	249 €
VCN800/2	HEDA000729	588 €	HEGA000380	837 €	HEGA000727	486 €	HEAA000382	365 €	HEAA000736	273 €
VCN900/2R	HEDA000732	616 €	HEGA000383	874 €	HEGA000730	517 €	HEAA000385	398 €	HEAA000739	297 €
VCN900/2	HEDA000731	616 €	HEGA000382	874 €	HEGA000729	517 €	HEAA000384	398 €	HEAA000738	297 €
VCN1000/2R	HEDA000734	743 €	HEGA000385	1,210 €	HEGA000732	630 €	HEAA000387	585 €	HEAA000741	347 €
VCN1000/2	HEDA000733	743 €	HEGA000384	1,210 €	HEGA000731	630 €	HEAA000386	585 €	HEAA000740	347 €
VCN1120/2R	N	N	HEGA000387	1,621 €	N	N	HEAA000389	991 €	N	N
VCN1120/2	N	N	HEGA000386	1,621 €	N	N	HEAA000388	991 €	N	N

VA/P - Ventilatoren

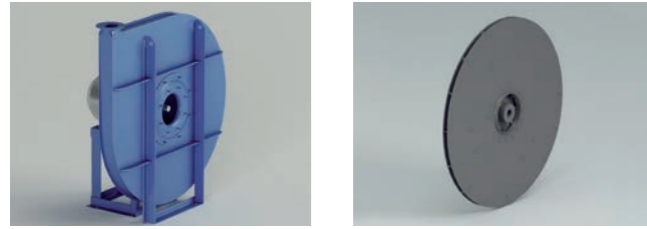

• **Arbeitsbereich:**
Niedrige - mittlere Fördermengen. Hohe Drücke

• **Laufrad:**
rückwärts gekrümmt, geschlossen.

Anwendungen:
Zum Transport von Stäuben, zur Trocknung und für mit Überdruck zu beaufschlagende Räume. Zur Verwendung im industriellen Bereich, Giessereien, Nudelfabriken, Öfen und der Chemie geeignet.

Technische Spezifikationen:
Luftvolumen : 50 bis 1.500 m³/h.
Gesamtdruck : 180 bis 2.100 daPa.

Ventilator	Max-Umdrehungen (rpm)			
	Größe	KLASSE I	KLASSE II	KLASSE III
VA310	5000	-	-	-
VA350	5000	-	-	-
VA400	5000	-	-	-
VA450/R	5000	-	-	-
VA450	5000	-	-	-
VA500	5000	-	-	-
VA560/R	5000	-	-	-
VA560	4700	5000	-	-
VA630/R	4400	4850	-	-

Ventilator	Max-Umdrehungen (rpm)			
	Größe	KLASSE I	KLASSE II	KLASSE III
VA630	4100	4550	5000	-
VA710/R	3700	4100	4500	-
VA710	3550	3850	4250	-
VA800/R	3400	3700	4000	-
VA800	3250	3550	3850	-
VA900/R	3100	3400	3700	-
VA900	2960	3250	3550	-
VA1000/R	3100	3550	3850	-
VA1000	3300	3550	3900	-

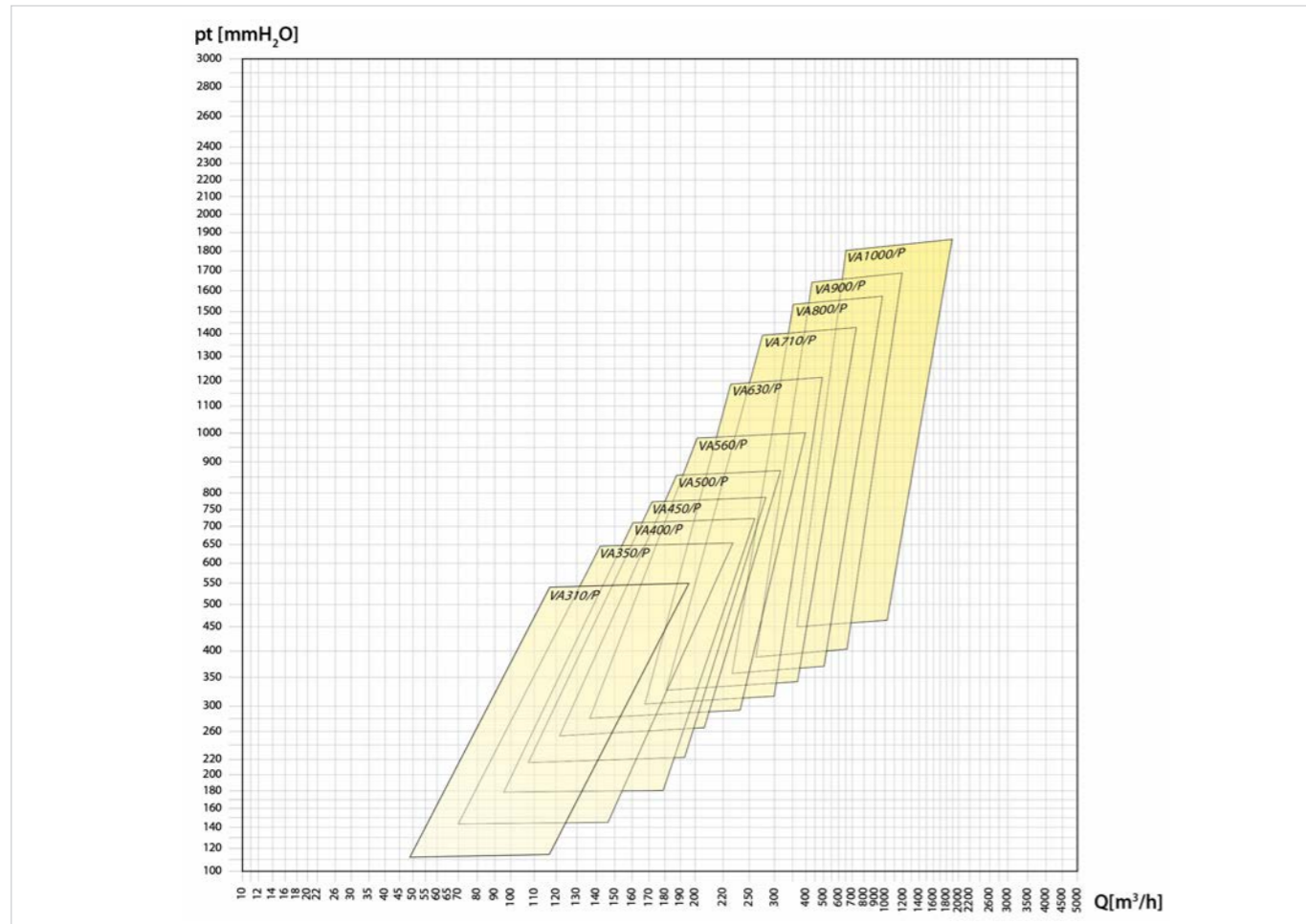

Typ	Gr	kW	Pole	EX4		EX5		ID		HT	
				Code	Preis	Code	Preis	Code	Preis	Code	Preis
VAP310/2	63	0,25	2	HBAA006705	690 €	HBAB000383	533 €	HDCA000418	64 €	N	N
VAP350/2	71	0,37	2	HBAA006719	706 €	HBAB000384	610 €	HDCA000419	64 €	HDEA000431	111 €
VAP400/2	71	0,55	2	HBAA006733	832 €	HBAB000385	694 €	HDCA000420	64 €	HDEA000432	111 €
VAP450/2	80	0,75	2	HBAA006747	930 €	HBAB000386	776 €	HDCA000421	64 €	HDEA000433	111 €
VAP500/2	80	1,1	2	HBAA006761	993 €	HBAB000387	841 €	HDCA000422	64 €	HDEA000434	111 €
VAP560/2	90	1,5	2	HBAA006775	1,302 €	HBAB000388	1,239 €	HDCA000423	90 €	HDEA000435	174 €
VAP630/2R	90	1,5	2	HBAA006803	1,420 €	HBAB000390	1,270 €	HDCA000425	90 €	HDEA000437	174 €
VAP630/2	90	2,2	2	HBAA006789	1,420 €	HBAB000389	1,270 €	HDCA000424	90 €	HDEA000436	174 €
VAP710/2R	100	3	2	HBAA006833	1,757 €	HBAB000392	1,747 €	HDCA000427	113 €	HDEA000439	174 €
VAP710/2	112	4	2	HBAA006817	1,757 €	HBAB000391	1,747 €	HDCA000426	113 €	HDEA000438	174 €
VAP800/2R	112	4	2	HBAA006865	2,159 €	HBAB000394	2,181 €	HDCA000429	113 €	HDEA000441	174 €
VAP800/2	132	5,5	2	HBAA006849	2,159 €	HBAB000393	2,181 €	HDCA000428	113 €	HDEA000440	276 €
VAP900/2R	132	7,5	2	HBAA006897	2,894 €	N	N	HDCA000431	113 €	HDEA000444	276 €
VAP900/2	160	11	2	HBAA006881	2,894 €	N	N	HDCA000430	113 €	HDEA000443	276 €
VAP1000/2R	160	18,5	2	HBAA006929	4,474 €	N	N	HDCA000433	113 €	HDEA000446	276 €
VAP1000/2	180	22	2	HBAA006913	4,474 €	N	N	HDCA000432	113 €	HDEA000445	276 €

Typ	TEN		DP		WC		FS		Extra 2GD EX.4	
	Code	Preis	Code	Preis	Code	Preis	Code	Preis	Code	Preis
VAP310/2	N	N	HDDA000418	49 €	N	N	N	N	N	N
VAP350/2	HGBA000432	111 €	HDDA000419	49 €	N	N	N	N	HEDA000414	475 €
VAP400/2	HGBA000433	111 €	HDDA000420	49 €	HDBA000420	C	HDAA000419	85 €	HEDA000415	517 €
VAP450/2	HGBA000434	111 €	HDDA000421	49 €	HDBA000421	C	HDAA000420	92 €	HEDA000416	518 €
VAP500/2	HGBA000435	111 €	HDDA000422	49 €	HDBA000422	C	HDAA000421	102 €	HEDA000417	524 €
VAP560/2	HGBA000436	174 €	HDDA000423	49 €	HDBA000423	C	HDAA000422	108 €	HEDA000418	682 €
VAP630/2R	HGBA000438	174 €	HDDA000425	49 €	HDBA000425	C	HDAA000424	111 €	HEDA000420	682 €
VAP630/2	HGBA000437	174 €	HDDA000424	49 €	HDBA000424	C	HDAA000423	111 €	HEDA000419	682 €
VAP710/2R	HGBA000440	174 €	HDDA000427	78 €	HDBA000427	C	HDAA000426	161 €	HEDA000422	724 €
VAP710/2	HGBA000439	174 €	HDDA000426	78 €	HDBA000426	C	HDAA000425	161 €	HEDA000421	724 €
VAP800/2R	HGBA000442	174 €	HDDA000429	78 €	HDBA000429	C	HDAA000428	196 €	HEDA000424	724 €
VAP800/2	HGBA000441	276 €	HDDA000428	78 €	HDBA000428	C	HDAA000427	196 €	HEDA000423	938 €
VAP900/2R	HGBA000445	276 €	HDDA000431	78 €	HDBA000431	C	HDAA000430	253 €	HEDA000426	976 €
VAP900/2	HGBA000444	276 €	HDDA000430	78 €	HDBA000430	C	HDAA000429	253 €	HEDA000425	976 €
VAP1000/2R	HGBA000447	276 €	N	N	HDBA000433	C	HDAA000432	266 €	HEDA000428	1,480 €
VAP1000/2	HGBA000446	276 €	HDDA000432	78 €	HDBA000432	C	HDAA000431	266 €	HEDA000427	1,480 €

Typ	Extra 2GD EX.5		Extra 3GD EX.4		Extra 3GD EX.5		Extra Tipo C EX.4		Extra Tipo C EX.5	
	Code	Preis	Code	Preis	Code	Preis	Code	Preis	Code	Preis
VAP310/2	HEDA000757	354 €	N	N	HEGA000755	238 €	N	N	HEAA000764	123 €
VAP350/2	HEDA000758	354 €	HEGA000412	356 €	HEGA000756	239 €	HEAA000414	133 €	HEAA000765	123 €
VAP400/2	HEDA000759	372 €	HEGA000413	398 €	HEGA000757	258 €	HEAA000415	157 €	HEAA000766	123 €
VAP450/2	HEDA000760	386 €	HEGA000414	399 €	HEGA000758	273 €	HEAA000416	157 €	HEAA000767	136 €
VAP500/2	HEDA000761	389 €	HEGA000415	405 €	HEGA000759	277 €	HEAA000417	161 €	HEAA000768	137 €
VAP560/2	HEDA000762	433 €	HEGA000416	563 €	HEGA000760	322 €	HEAA000418	214 €	HEAA000769	139 €
VAP630/2R	HEDA000764	433 €	HEGA000418	563 €	HEGA000762	321 €	HEAA000420	214 €	HEAA000771	139 €
VAP630/2	HEDA000763	433 €	HEGA000417	563 €	HEGA000761	321 €	HEAA000419	214 €	HEAA000770	139 €
VAP710/2R	HEDA000766	504 €	HEGA000420	605 €	HEGA000764	395 €	HEAA000422	230 €	HEAA000773	183 €
VAP710/2	HEDA000765	504 €	HEGA000419	605 €	HEGA000763	395 €	HEAA000421	230 €	HEAA000772	183 €
VAP800/2R	N	N	HEGA000422	717 €	N	N	HEAA000424	323 €	HEAA000775	188 €
VAP800/2	N	N	HEGA000421	819 €	N	N	HEAA000423	323 €	HEAA000774	207 €
VAP900/2R	N	N	HEGA000424	857 €	N	N	HEAA000426	357 €	N	N
VAP900/2	N	N	HEGA000423	857 €	N	N	HEAA000425	357 €	N	N
VAP1000/2R	N	N	HEGA000426	1,340 €	N	N	HEAA000428	802 €	N	N
VAP1000/2	N	N	HEGA000425	1,340 €	N	N	HEAA000427	802 €	N	N

ZA - Ventilatoren

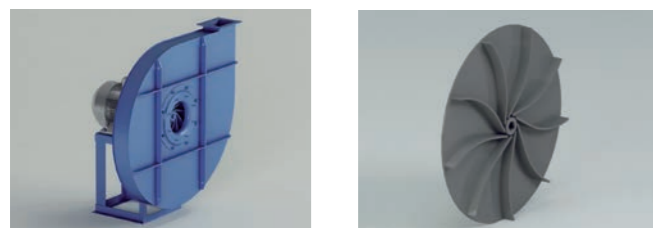

• Arbeitsbereich :
 Niedrige Fördermengen. Hohe Drücke
• Laufrad :
 rückwärts gekrümmt, offen
Anwendungen :
 Zum Transport von in Luft vermischten Feststoffen, Sägestaub und Holzspäne, auch für fadenförmige Materialien, die einen geschlossenen Ventilator mit rückwärts gekrümmten Schaufeln zusetzen würden.
Technische Spezifikationen :
 Luftvolumen : 180 bis 3.600 m³/h.
 Gesamtdruck : 140 bis 1.000 daPa.

Ventilator	Max-Umdrehungen (rpm)
Größe	KLASSE I
ZA400	5300
ZA450	4750
ZA500	4250
ZA560	3750
ZA630	3350

Ventilator	Max-Umdrehungen (rpm)
Größe	KLASSE I
ZA710	3000
ZA800	2960
ZA900	26350
ZA1000	2100

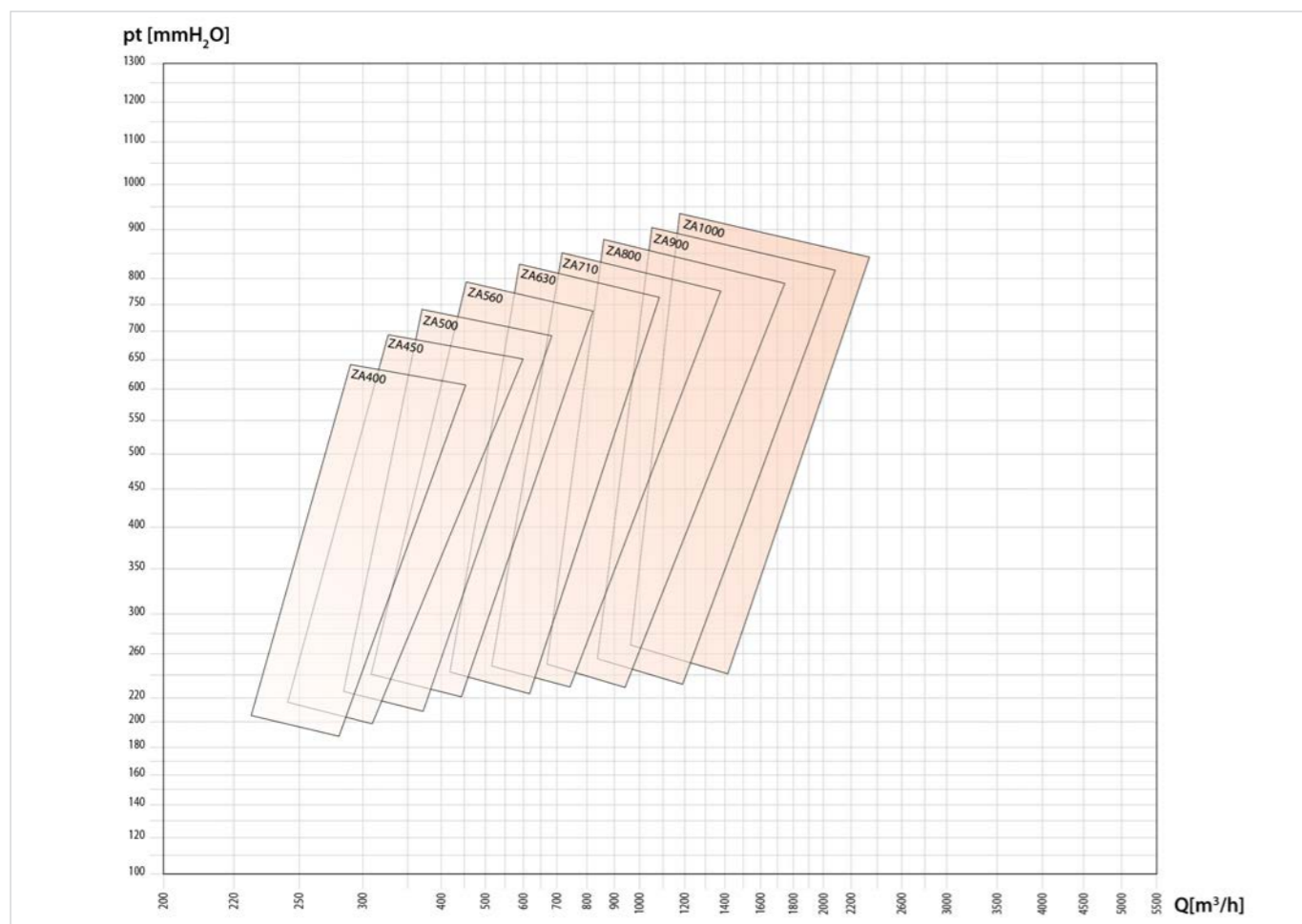

Typ	Gr	kW	Pole	EX4		EX5		ID		HT	
				Code	Preis	Code	Preis	Code	Preis	Code	Preis
ZA400/2	80	0,75	2	HBAA006335	869 €	HBAB000359	805 €	HDCA000394	57 €	HDEA000406	111 €
ZA450/2	80	1,1	2	HBAA006349	942 €	HBAB000360	853 €	HDCA000395	57 €	HDEA000407	111 €
ZA500/2	90	2,2	2	HBAA006363	1,183 €	HBAB000361	1,077 €	HDCA000396	64 €	HDEA000409	174 €
ZA560/2	100	3	2	HBAA006377	1,575 €	HBAB000362	1,490 €	HDCA000397	64 €	HDEA000410	174 €
ZA630/2	132	5,5	2	HBAA006391	1,957 €	HBAB000363	1,824 €	HDCA000398	90 €	HDEA000411	276 €
ZA710/2	132	7,5	2	HBAA006405	2,316 €	HBAB000364	2,120 €	HDCA000399	90 €	HDEA000412	276 €
ZA800/4R	100	3	4	HBAA006469	3,137 €	HBAB000368	2,822 €	HDCA000403	90 €	HDEA000416	174 €
ZA800/4	112	4	4	HBAA006453	3,137 €	HBAB000367	2,822 €	HDCA000402	90 €	HDEA000415	174 €
ZA800/2R	160	15	2	HBAA006437	3,137 €	HBAB000366	2,822 €	HDCA000401	90 €	HDEA000414	276 €
ZA800/2	160	18,5	2	HBAA006421	3,137 €	HBAB000365	2,822 €	HDCA000400	90 €	HDEA000413	276 €
ZA900/4R	132	5,5	4	HBAA006501	4,246 €	HBAB000370	3,661 €	HDCA000405	90 €	HDEA000418	276 €
ZA900/4	132	7,5	4	HBAA006485	4,246 €	HBAB000369	3,661 €	HDCA000404	90 €	HDEA000417	276 €
ZA1000/4R	132	7,5	4	HBAA006533	6,135 €	HBAB000372	5,529 €	HDCA000407	113 €	HDEA000420	276 €
ZA1000/4	160	11	4	HBAA006517	6,135 €	HBAB000371	5,529 €	HDCA000406	113 €	HDEA000419	276 €

Typ	TEN		DP		WC		FS		Extra 2GD EX.4	
	Code	Preis	Code	Preis	Code	Preis	Code	Preis	Code	Preis
ZA400/2	HGBA000407	111 €	HDDA000394	49 €	HDBA000396	167 €	HDAA000395	85 €	HEDA000390	664 €
ZA450/2	HGBA000408	111 €	HDDA000395	49 €	HDBA000397	207 €	HDAA000396	92 €	HEDA000391	718 €
ZA500/2	HGBA000410	174 €	HDDA000396	49 €	HDBA000398	234 €	HDAA000397	102 €	HEDA000392	832 €
ZA560/2	HGBA000411	174 €	HDDA000397	49 €	HDBA000399	C	HDAA000398	108 €	HEDA000393	668 €
ZA630/2	HGBA000412	276 €	HDDA000398	49 €	HDBA000400	C	HDAA000399	111 €	HEDA000394	815 €
ZA710/2	HGBA000413	276 €	HDDA000399	78 €	HDBA000401	C	HDAA000400	161 €	HEDA000395	841 €
ZA800/4R	HGBA000417	174 €	HDDA000403	78 €	HDBA000405	C	HDAA000404	196 €	HEDA000399	874 €
ZA800/4	HGBA000416	174 €	HDDA000402	78 €	HDBA000404	C	HDAA000403	196 €	HEDA000398	874 €
ZA800/2R	HGBA000415	276 €	HDDA000401	78 €	HDBA000403	C	HDAA000402	196 €	HEDA000397	976 €
ZA800/2	HGBA000414	276 €	HDDA000400	78 €	HDBA000402	C	HDAA000401	196 €	HEDA000396	976 €
ZA900/4R	HGBA000419	276 €	HDDA000405	78 €	HDBA000407	C	HDAA000406	253 €	HEDA000401	1,018 €
ZA900/4	HGBA000418	276 €	HDDA000404	78 €	HDBA000406	C	HDAA000405	253 €	HEDA000400	724 €
ZA1000/4R	HGBA000421	276 €	HDDA000407	78 €	HDBA000409	C	HDAA000408	266 €	HEDA000403	1,266 €
ZA1000/4	HGBA000420	276 €	HDDA000406	78 €	HDBA000408	C	HDAA000407	266 €	HEDA000402	1,245 €

Typ	Extra 2GD EX.5		Extra 3GD EX.4		Extra 3GD EX.5		Extra Tipo C EX.4		Extra Tipo C EX.5	
	Code	Preis	Code	Preis	Code	Preis	Code	Preis	Code	Preis
ZA400/2	HEDA000735	532 €	HEGA000388	378 €	HEGA000733	251 €	HEAA000390	144 €	HEAA000742	123 €
ZA450/2	HEDA000736	587 €	HEGA000389	392 €	HEGA000734	266 €	HEAA000391	157 €	HEAA000743	136 €
ZA500/2	HEDA000737	634 €	HEGA000390	479 €	HEGA000735	288 €	HEAA000392	172 €	HEAA000744	148 €
ZA560/2	HEDA000738	451 €	HEGA000391	549 €	HEGA000736	342 €	HEAA000393	225 €	HEAA000745	182 €
ZA630/2	HEDA000739	515 €	HEGA000392	696 €	HEGA000737	406 €	HEAA000394	245 €	HEAA000746	221 €
ZA710/2	HEDA000740	563 €	HEGA000393	722 €	HEGA000738	433 €	HEAA000395	269 €	HEAA000747	242 €
ZA800/4R	HEDA000744	564 €	HEGA000397	857 €	HEGA000742	462 €	HEAA000399	385 €	HEAA000751	249 €
ZA800/4	HEDA000743	564 €	HEGA000396	857 €	HEGA000741	462 €	HEAA000398	385 €	HEAA000750	249 €
ZA800/2R	HEDA000742	608 €	HEGA000395	857 €	HEGA000740	507 €	HEAA000397	385 €	HEAA000749	293 €
ZA800/2	HEDA000741	608 €	HEGA000394	857 €	HEGA000739	507 €	HEAA000396	385 €	HEAA000748	293 €
ZA900/4R	HEDA000746	617 €	HEGA000399	899 €	HEGA000744	519 €	HEAA000401	423 €	HEAA000753	298 €
ZA900/4	HEDA000745	617 €	HEGA000398	899 €	HEGA000743	519 €	HEAA000400	423 €	HEAA000752	298 €
ZA1000/4R	HEDA000748	706 €	HEGA000401	1,126 €	HEGA000746	591 €	HEAA000403	594 €	HEAA000755	309 €
ZA1000/4	HEDA000747	729 €	HEGA000400	1,126 €	HEGA000745	615 €	HEAA000402	594 €	HEAA000754	333 €

ZB - Ventilatoren

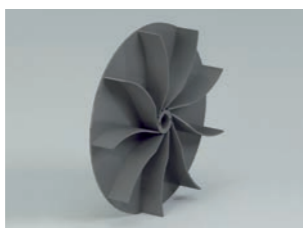
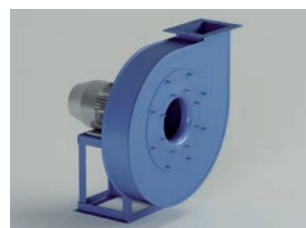

Arbeitsbereich :
 Niedrige - mittlere Fördermengen. Hohe Drücke
Laufgrad :
 rückwärts gekrümmt, offen
Anwendungen :
 Zum Transport von in Luft vermischten Feststoffen, Sägestaub und Holzspäne, auch für fadenförmige Materialien, die einen geschlossenen Ventilator mit rückwärts gekrümmten Schaufeln zusetzen würden.
Technische Spezifikationen :
 Luftvolumen : 450 bis 15.000 m³/h.
 Gesamtdruck : 200 bis 1.000 daPa.

Ventilator	Max-Umdrehungen (rpm)
Größe	KLASSE I
ZB400	5300
ZB450	4750
ZB500	4250
ZB560	3750
ZB630	3350
ZB710	3000

Ventilator	Max-Umdrehungen (rpm)
Größe	KLASSE I
ZB800	2960
ZB900	2350
ZB1000	2100
ZB1120	1900
ZB1250	1700

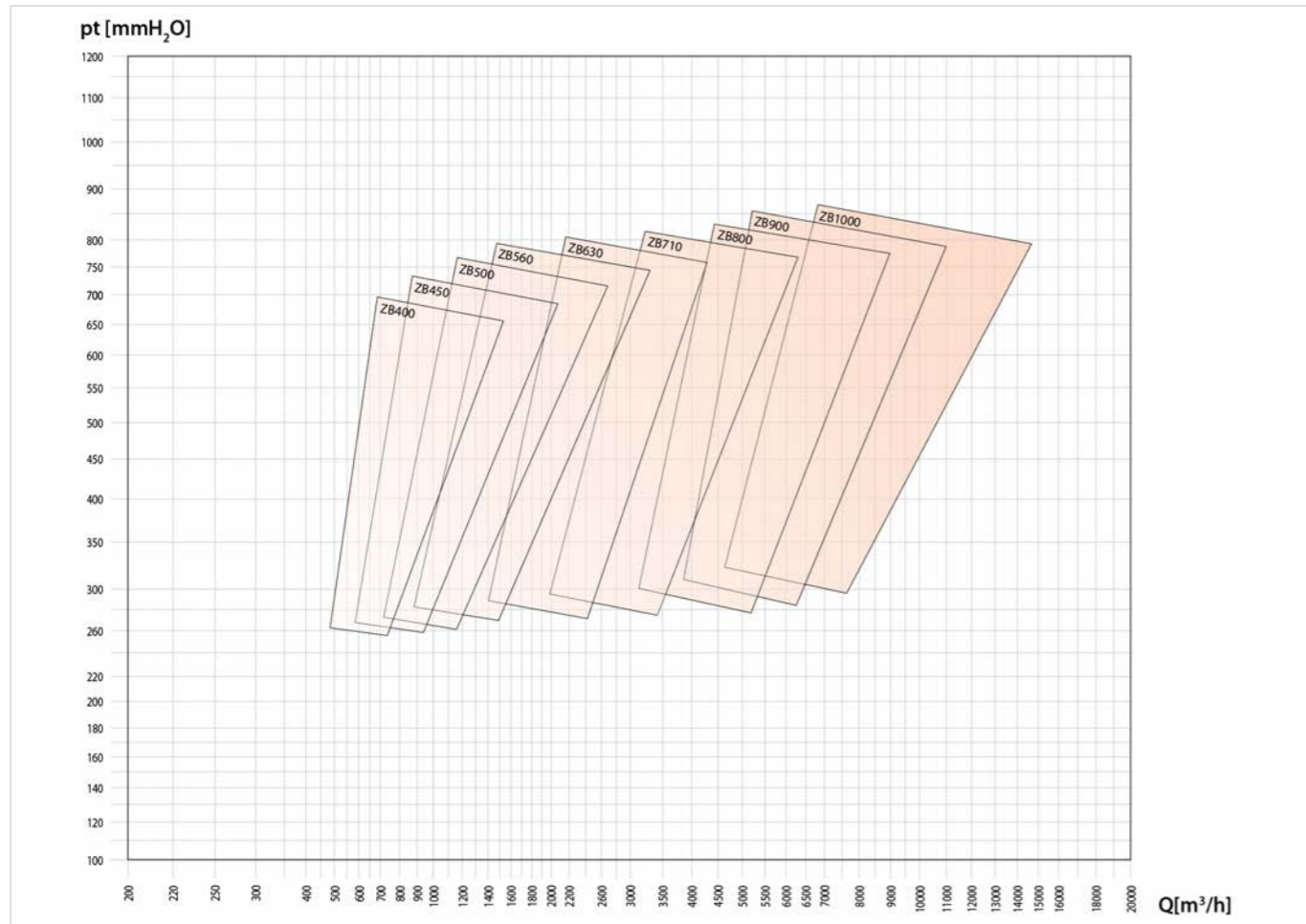

Typ	Gr	kW	Pole	EX4		EX5		ID		HT	
				Code	Preis	Code	Preis	Code	Preis	Code	Preis
ZB400/2	90	2,2	2	HBAA005191	907 €	HBAB000297	843 €	HDCA000323	57 €	HDEA000330	174 €
ZB450/2	100	3	2	HBAA005205	1,053 €	HBAB000298	963 €	HDCA000324	57 €	HDEA000331	174 €
ZB500/2	132	5,5	2	HBAA005219	1,316 €	HBAB000299	1,210 €	HDCA000325	64 €	HDEA000332	276 €
ZB560/2	132	7,5	2	HBAA005233	1,576 €	HBAB000300	1,491 €	HDCA000326	64 €	HDEA000333	276 €
ZB630/2	160	15	2	HBAA005247	1,854 €	HBAB000301	1,721 €	HDCA000327	90 €	HDEA000334	276 €
ZB710/2R	180	22	2	HBAA005277	2,507 €	HBAB000303	2,311 €	HDCA000329	90 €	HDEA000336	276 €
ZB710/2	200	30	2	HBAA005261	2,678 €	HBAB000302	2,432 €	HDCA000328	90 €	HDEA000335	368 €
ZB800/4R	132	7,5	4	HBAA005341	3,919 €	HBAB000307	3,604 €	HDCA000333	90 €	HDEA000340	276 €
ZB800/4	160	11	4	HBAA005325	3,919 €	HBAB000306	3,604 €	HDCA000332	90 €	HDEA000339	276 €
ZB800/2R	200	37	2	HBAA005309	3,919 €	HBAB000305	4,061 €	HDCA000331	90 €	HDEA000338	368 €
ZB800/2	225	45	2	HBAA005293	4,080 €	HBAB000304	4,061 €	HDCA000330	90 €	HDEA000337	368 €
ZB900/4R	160	11	4	HBAA005373	5,211 €	HBAB000309	4,626 €	HDCA000335	90 €	HDEA000342	276 €
ZB900/4	160	15	4	HBAA005357	5,211 €	HBAB000308	4,626 €	HDCA000334	90 €	HDEA000341	276 €
ZB1000/4R	180	18,5	4	HBAA005405	7,673 €	HBAB000311	7,067 €	HDCA000337	113 €	HDEA000344	276 €
ZB1000/4	180	22	4	HBAA005389	7,673 €	HBAB000310	7,067 €	HDCA000336	113 €	HDEA000343	276 €

Typ	TEN		DP		WC		FS		Extra 2GD EX.4	
	Code	Preis	Code	Preis	Code	Preis	Code	Preis	Code	Preis
ZB400/2	HGBA000332	174 €	HDDA000323	49 €	HDBA000325	167 €	HDAA000324	85 €	HEDA000320	769 €
ZB450/2	HGBA000333	174 €	HDDA000324	49 €	HDBA000326	181 €	HDAA000325	92 €	HEDA000321	802 €
ZB500/2	HGBA000334	276 €	HDDA000325	49 €	HDBA000327	234 €	HDAA000326	102 €	HEDA000322	990 €
ZB560/2	HGBA000335	276 €	HDDA000326	49 €	HDBA000328	262 €	HDAA000327	108 €	HEDA000323	1,110 €
ZB630/2	HGBA000336	276 €	HDDA000327	49 €	HDBA000329	290 €	HDAA000328	111 €	HEDA000324	1,170 €
ZB710/2R	HGBA000338	276 €	HDDA000329	78 €	HDBA000331	C	HDAA000330	161 €	HEDA000326	893 €
ZB710/2	HGBA000337	368 €	HDDA000328	78 €	HDBA000330	C	HDAA000329	161 €	HEDA000325	986 €
ZB800/4R	HGBA000342	276 €	HDDA000333	78 €	HDBA000335	C	HDAA000334	196 €	HEDA000330	724 €
ZB800/4	HGBA000341	276 €	HDDA000332	78 €	HDBA000334	C	HDAA000333	196 €	HEDA000329	1,056 €
ZB800/2R	HGBA000340	368 €	HDDA000331	78 €	HDBA000333	C	HDAA000332	196 €	HEDA000328	1,148 €
ZB800/2	HGBA000339	368 €	HDDA000330	78 €	HDBA000332	C	HDAA000331	196 €	HEDA000327	1,148 €
ZB900/4R	HGBA000344	276 €	HDDA000335	78 €	HDBA000337	C	HDAA000336	253 €	HEDA000332	1,109 €
ZB900/4	HGBA000343	276 €	HDDA000334	78 €	HDBA000336	C	HDAA000335	253 €	HEDA000331	1,109 €
ZB1000/4R	HGBA000346	276 €	HDDA000337	78 €	HDBA000339	C	HDAA000338	266 €	HEDA000334	1,359 €
ZB1000/4	HGBA000345	276 €	HDDA000336	78 €	HDBA000338	C	HDAA000337	266 €	HEDA000333	1,359 €

Typ	Extra 2GD EX.5		Extra 3GD EX.4		Extra 3GD EX.5		Extra Tipo C EX.4		Extra Tipo C EX.5	
	Code	Preis	Code	Preis	Code	Preis	Code	Preis	Code	Preis
ZB400/2	HEDA000680	574 €	HEGA000318	483 €	HEGA000678	332 €	HEAA000320	186 €	HEAA000683	165 €
ZB450/2	HEDA000681	640 €	HEGA000319	503 €	HEGA000679	396 €	HEAA000321	204 €	HEAA000684	216 €
ZB500/2	HEDA000682	742 €	HEGA000320	637 €	HEGA000680	420 €	HEAA000322	228 €	HEAA000685	256 €
ZB560/2	HEDA000683	811 €	HEGA000321	729 €	HEGA000681	489 €	HEAA000323	304 €	HEAA000686	280 €
ZB630/2	HEDA000684	895 €	HEGA000322	1,051 €	HEGA000682	489 €	HEAA000324	311 €	HEAA000687	311 €
ZB710/2R	HEDA000686	615 €	HEGA000324	774 €	HEGA000684	445 €	HEAA000326	321 €	HEAA000689	318 €
ZB710/2	HEDA000685	637 €	HEGA000323	867 €	HEGA000683	445 €	HEAA000325	321 €	HEAA000688	340 €
ZB800/4R	HEDA000690	664 €	HEGA000328	937 €	HEGA000688	566 €	HEAA000330	465 €	HEAA000693	349 €
ZB800/4	HEDA000689	664 €	HEGA000327	937 €	HEGA000687	589 €	HEAA000329	465 €	HEAA000692	349 €
ZB800/2R	HEDA000688	710 €	HEGA000326	1,029 €	HEGA000686	498 €	HEAA000328	465 €	HEAA000691	395 €
ZB800/2	HEDA000687	745 €	HEGA000325	1,029 €	HEGA000685	498 €	HEAA000327	465 €	HEAA000690	430 €
ZB900/4R	HEDA000692	732 €	HEGA000330	990 €	HEGA000690	445 €	HEAA000332	514 €	HEAA000695	413 €
ZB900/4	HEDA000691	732 €	HEGA000329	990 €	HEGA000689	417 €	HEAA000331	514 €	HEAA000694	413 €
ZB1000/4R	HEDA000694	823 €	HEGA000332	1,219 €	HEGA000692	514 €	HEAA000334	687 €	HEAA000697	427 €
ZB1000/4	HEDA000693	823 €	HEGA000331	1,219 €	HEGA000691	514 €	HEAA000333	687 €	HEAA000696	427 €

ZD - Ventilatoren

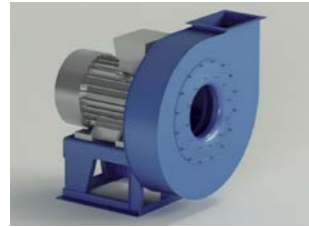

- **Arbeitsbereich :**
Niedrige - mittlere Fördermengen. Hohe Drücke
- **Laufrad :**
rückwärts gekrümmt, offen
- **Anwendungen :**
Zum Transport von in Luft vermischten Feststoffen, Sägestaub und Holzspäne, auch für fadenförmige Materialien, die einen geschlossenen Ventilator mit rückwärts gekrümmten Schaufeln zusetzen würden.
- **Technische Spezifikationen :**
Luftvolumen : 1.400 bis 25.000 m³/h.
Gesamtdruck : 140 bis 350 daPa.

Typ	Gr	kW	Pole	EX4		EX5		ID		HT	
				Code	Preis	Code	Preis	Code	Preis	Code	Preis
ZD560/4	100	3	4	HBAA006549	1,460 €	HBAB000373	1,375 €	HDCA000408	64 €	HDEA000421	174 €
ZD630/4	112	4	4	HBAA006563	1,635 €	HBAB000374	1,502 €	HDCA000409	90 €	HDEA000422	276 €
ZD710R(670)/4	132	5,5	4	HBAA006577	1,950 €	HBAB000375	1,754 €	HDCA000410	90 €	HDEA000423	276 €
ZD800R(750)/4	160	11	4	HBAA006609	2,752 €	HBAB000377	2,437 €	HDCA000412	90 €	HDEA000425	276 €
ZD900R(830)/4	180	18,5	4	HBAA006625	3,500 €	HBAB000378	2,915 €	HDCA000413	90 €	HDEA000426	368 €
ZD1000/4R	225	37	4	HBAA006689	6,833 €	HBAB000382	6,227 €	HDCA000417	113 €	HDEA000430	431 €
ZD1000/4	225	45	4	HBAA006673	6,833 €	HBAB000381	1,478 €	HDCA000416	113 €	HDEA000429	431 €

Typ	TEN		DP		WC		FS		Extra 2GD EX.4	
	Code	Preis	Code	Preis	Code	Preis	Code	Preis	Code	Preis
ZD560/4	HGBA000422	174 €	HDDA000408	49 €	HDBA000410	290 €	HDAA000409	108 €	HEDA000404	1,043 €
ZD630/4	HGBA000423	276 €	HDDA000409	49 €	HDBA000411	290 €	HDAA000410	111 €	HEDA000405	1,173 €
ZD710R(670)/4	HGBA000424	276 €	HDDA000410	78 €	HDBA000412	400 €	HDAA000411	161 €	HEDA000406	1,336 €
ZD800R(750)/4	HGBA000426	368 €	HDDA000412	78 €	HDBA000414	469 €	HDAA000413	196 €	HEDA000408	1,649 €
ZD900R(830)/4	HGBA000427	368 €	HDDA000413	78 €	HDBA000415	580 €	HDAA000414	253 €	HEDA000409	1,789 €
ZD1000/4R	HGBA000431	431 €	HDDA000417	78 €	HDBA000419	C	HDAA000418	266 €	HEDA000413	1,515 €
ZD1000/4	HGBA000430	431 €	HDDA000416	78 €	HDBA000418	C	HDAA000417	266 €	HEDA000412	1,515 €

Typ	Extra 2GD EX.5		Extra 3GD EX.4		Extra 3GD EX.5		Extra Tipo C EX.4		Extra Tipo C EX.5	
	Code	Preis	Code	Preis	Code	Preis	Code	Preis	Code	Preis
ZD560/4	HEDA000749	826 €	HEGA000402	634 €	HEGA000747	430 €	HEAA000404	311 €	HEAA000756	235 €
ZD630/4	HEDA000750	854 €	HEGA000403	764 €	HEGA000748	456 €	HEAA000405	314 €	HEAA000757	270 €
ZD710R(670)/4	HEDA000751	1,033 €	HEGA000404	816 €	HEGA000749	531 €	HEAA000406	363 €	HEAA000758	336 €
ZD800R(750)/4	HEDA000753	1,189 €	HEGA000406	1,530 €	HEGA000751	1,093 €	HEAA000408	497 €	HEAA000760	405 €
ZD900R(830)/4	HEDA000754	1,320 €	HEGA000407	1,670 €	HEGA000752	1,092 €	HEAA000409	522 €	HEAA000761	421 €
ZD1000/4R	N	N	HEGA000411	1,375 €	N	N	HEAA000413	687 €	N	N
ZD1000/4	N	N	HEGA000410	1,375 €	N	N	HEAA000412	687 €	N	N

Mehrpreis Mitteldruck



Mehrpreis Mitteldruck AISI 304 L												
Größe	Ex. 4	Ex. 5	Teile in kontakt	ID	DP	TEN single	TEN doppelt	TEN Dichtung	HT	Laufrad	Ansaugöffnung	FS
180	886 €	766 €	766 €	17 €	17 €	49 €	R	R	34 €	279 €	134 €	R
200	910 €	790 €	790 €	17 €	17 €	49 €	R	R	34 €	279 €	137 €	R
220	1,008 €	876 €	876 €	17 €	17 €	49 €	R	R	34 €	304 €	164 €	R
250	1,107 €	962 €	962 €	17 €	17 €	49 €	R	R	34 €	329 €	192 €	97 €
280	1,179 €	962 €	962 €	17 €	17 €	49 €	R	R	34 €	353 €	196 €	97 €
310	1,422 €	1,156 €	1,156 €	17 €	17 €	49 €	R	R	34 €	402 €	234 €	120 €
350	1,735 €	1,302 €	1,302 €	27 €	17 €	49 €	99 €	197 €	34 €	426 €	245 €	144 €
400	2,243 €	1,737 €	1,737 €	27 €	17 €	66 €	132 €	263 €	46 €	620 €	287 €	168 €
450	2,484 €	1,954 €	1,954 €	27 €	17 €	66 €	132 €	263 €	46 €	715 €	325 €	217 €
500	2,773 €	2,099 €	2,099 €	27 €	17 €	66 €	132 €	263 €	46 €	836 €	342 €	265 €
560	4,190 €	3,322 €	3,322 €	27 €	17 €	66 €	132 €	263 €	46 €	1,142 €	428 €	314 €
630	5,057 €	4,094 €	4,094 €	27 €	17 €	66 €	132 €	263 €	46 €	1,383 €	584 €	385 €
710	7,204 €	5,397 €	5,397 €	C	27 €	83 €	165 €	329 €	59 €	1,697 €	682 €	434 €
800	9,191 €	6,590 €	6,590 €	C	27 €	83 €	165 €	329 €	59 €	2,456 €	755 €	531 €
900	12,684 €	9,384 €	9,384 €	C	27 €	83 €	165 €	329 €	59 €	3,058 €	851 €	C
1000	16,953 €	R	11,532 €	C	27 €	83 €	165 €	329 €	59 €	4,633 €	1,093 €	C
1120	24,588 €	N	17,604 €	C	27 €	297 €	533 €	889 €	297 €	7,813 €	1,239 €	C
1250	28,202 €	N	20,012 €	C	27 €	297 €	533 €	889 €	297 €	9,740 €	1,600 €	C
1400	37,836 €	N	24,107 €	C	27 €	594 €	949 €	1,660 €	594 €	12,149 €	1,841 €	C
1600	51,561 €	N	34,699 €	C	27 €	594 €	949 €	1,660 €	594 €	18,549 €	2,300 €	C
1800	73,438 €	N	53,686 €	C	C	594 €	949 €	1,660 €	594 €	25,873 €	3,483 €	C
2000	102,641 €	N	74,939 €	C	C	594 €	949 €	1,660 €	594 €	30,839 €	5,076 €	C

Mehrpreis Mitteldruck AISI 316 L												
Größe	Ex. 4 complete	Ex. 5 complete	Teile in kontakt	ID	DP	TEN single	TEN doppelt	TEN Dichtung	HT	Laufrad	Ansaugöffnung	FS
180	1,254 €	1,047 €	1,047 €	17 €	17 €	56 €	R	R	39 €	350 €	161 €	R
200	1,296 €	1,088 €	1,088 €	17 €	17 €	56 €	R	R	39 €	350 €	165 €	R
220	1,413 €	1,183 €	1,183 €	17 €	17 €	56 €	R	R	39 €	374 €	195 €	R
250	1,527 €	1,278 €	1,278 €	17 €	17 €	56 €	R	R	39 €	399 €	223 €	167 €
280	1,653 €	1,278 €	1,278 €	17 €	17 €	56 €	R	R	39 €	441 €	231 €	167 €
310	2,019 €	1,561 €	1,561 €	17 €	17 €	56 €	R	R	39 €	507 €	277 €	209 €
350	2,559 €	1,810 €	1,810 €	27 €	17 €	56 €	112 €	224 €	39 €	549 €	298 €	249 €
400	3,367 €	2,492 €	2,492 €	27 €	17 €	73 €	146 €	290 €	53 €	847 €	351 €	291 €
450	3,783 €	2,867 €	2,867 €	27 €	17 €	73 €	146 €	290 €	53 €	1,014 €	419 €	375 €
500	4,283 €	3,116 €	3,116 €	27 €	17 €	73 €	146 €	290 €	53 €	1,222 €	448 €	458 €
560	6,594 €	5,095 €	5,095 €	27 €	17 €	73 €	146 €	290 €	53 €	1,686 €	560 €	542 €
630	8,092 €	6,427 €	6,427 €	27 €	17 €	73 €	146 €	290 €	53 €	2,103 €	830 €	666 €
710	11,697 €	8,574 €	8,574 €	C	27 €	92 €	185 €	370 €	66 €	2,610 €	963 €	749 €
800	15,070 €	10,573 €	10,573 €	C	27 €	92 €	185 €	370 €	66 €	3,860 €	1,088 €	916 €
900	21,106 €	15,403 €	15,403 €	C	27 €	92 €	185 €	370 €	66 €	4,900 €	1,254 €	C
1000	28,358 €	R	18,990 €	C	27 €	92 €	185 €	370 €	66 €	7,353 €	1,603 €	C
1120	41,258 €	N	29,184 €	C	27 €	395 €	711 €	1,186 €	395 €	12,551 €	1,852 €	C
1250	47,503 €	N	33,348 €	C	27 €	395 €	711 €	1,186 €	395 €	15,882 €	2,477 €	C
1400	64,158 €	N	40,426 €	C	27 €	757 €	1,212 €	2,121 €	757 €	20,045 €	2,894 €	C
1600	86,656 €	N	57,511 €	C	27 €	757 €	1,212 €	2,121 €	757 €	29,954 €	3,616 €	C
1800	124,326 €	N	90,184 €	C	C	757 €	1,212 €	2,121 €	757 €	42,543 €	5,589 €	C
2000	174,584 €	N	126,704 €	C	C	757 €	1,212 €	2,121 €	757 €	51,019 €	8,236 €	C

Mehrpreis Hochruck



Mehrpreis Hochruck AISI 304 L													
Größe	Ex. 4	Ex. 5	Teile in kontakt	ID	DP	TEN single	TEN doppelt	TEN Dichtung	HT	Laufrad	Ans-augöf-fnung VM-VG-ZB-VI	Ans-augöf-fnung VA-ZA-VC-VP	FS
180	N	N	N	N	N	N	R	R	N	N	N	N	N
200	N	N	N	N	N	N	R	R	N	N	N	N	N
220	N	N	N	N	N	N	R	R	N	N	N	N	N
250	N	N	N	N	N	N	R	R	N	N	N	N	N
280	N	N	N	N	N	N	R	R	N	N	N	N	N
310	1,667 €	1,547 €	1,547 €	27 €	17 €	49 €	R	R	34 €	426 €	221 €	211 €	60 €
350	1,667 €	1,547 €	1,547 €	27 €	17 €	49 €	99 €	197 €	34 €	426 €	221 €	211 €	60 €
400	1,959 €	1,742 €	1,742 €	27 €	17 €	49 €	99 €	197 €	34 €	522 €	258 €	238 €	73 €
450	2,152 €	1,911 €	1,911 €	27 €	17 €	49 €	99 €	197 €	34 €	643 €	270 €	241 €	84 €
500	2,513 €	2,079 €	2,079 €	27 €	17 €	66 €	132 €	263 €	46 €	715 €	287 €	246 €	84 €
560	3,304 €	2,726 €	2,726 €	27 €	17 €	66 €	132 €	263 €	46 €	925 €	375 €	307 €	97 €
630	4,220 €	3,570 €	3,570 €	27 €	17 €	66 €	132 €	263 €	46 €	1,166 €	392 €	319 €	97 €
710	5,670 €	4,707 €	4,707 €	34 €	27 €	66 €	132 €	263 €	46 €	1,456 €	477 €	385 €	C
800	7,440 €	5,272 €	5,272 €	34 €	27 €	83 €	165 €	329 €	59 €	2,142 €	634 €	424 €	C
900	11,535 €	8,163 €	8,163 €	34 €	27 €	83 €	165 €	329 €	59 €	2,649 €	682 €	441 €	C
1000	16,953 €	R	12,134 €	39 €	27 €	83 €	165 €	329 €	59 €	4,271 €	853 €	575 €	C
1120	21,288 €	N	14,302 €	39 €	27 €	297 €	533 €	889 €	297 €	5,235 €	949 €	732 €	C
1250	29,406 €	N	21,216 €	C	27 €	297 €	533 €	889 €	297 €	8,295 €	1,093 €	781 €	C
1400	45,063 €	N	33,019 €	C	27 €	594 €	949 €	1,660 €	594 €	10,945 €	1,239 €	853 €	C
1600	56,379 €	N	39,516 €	C	27 €	594 €	949 €	1,660 €	594 €	14,454 €	1,698 €	1,049 €	C
1800	71,029 €	N	51,276 €	C	C	594 €	949 €	1,660 €	594 €	22,260 €	3,965 €	N	C
2000	100,232 €	N	72,530 €	C	C	594 €	949 €	1,660 €	594 €	27,226 €	5,076 €	N	C

Mehrpreis Hochruck AISI 316 L													
Größe	Ex. 4	Ex. 5	Teile in kontakt	ID	DP	TEN single	TEN doppelt	TEN Dichtung	HT	Laufrad	Ans-augöf-fnung VM-VG-ZB-VI	Ans-augöf-fnung VA-ZA-VC-VP	FS
180	N	N	N	N	N	N	R	R	N	N	N	N	N
200	N	N	N	N	N	N	R	R	N	N	N	N	N
220	N	N	N	N	N	N	R	R	N	N	N	N	N
250	N	N	N	N	N	N	R	R	N	N	N	N	N
280	N	N	N	N	N	N	R	R	N	N	N	N	N
310	2,316 €	2,108 €	2,108 €	27 €	17 €	56 €	R	R	39 €	549 €	256 €	239 €	104 €
350	2,316 €	2,108 €	2,108 €	27 €	17 €	56 €	112 €	224 €	39 €	549 €	256 €	239 €	104 €
400	2,748 €	2,373 €	2,373 €	27 €	17 €	56 €	112 €	224 €	39 €	699 €	302 €	269 €	125 €
450	3,081 €	2,666 €	2,666 €	27 €	17 €	56 €	112 €	224 €	39 €	906 €	322 €	273 €	146 €
500	3,706 €	2,957 €	2,957 €	27 €	17 €	73 €	146 €	290 €	53 €	1,030 €	351 €	281 €	146 €
560	4,883 €	3,885 €	3,885 €	27 €	17 €	73 €	146 €	290 €	53 €	1,312 €	468 €	351 €	167 €
630	6,465 €	5,341 €	5,341 €	27 €	17 €	73 €	146 €	290 €	53 €	1,728 €	497 €	372 €	167 €
710	8,828 €	7,164 €	7,164 €	34 €	27 €	73 €	146 €	290 €	53 €	2,194 €	609 €	451 €	C
800	11,827 €	8,079 €	8,079 €	34 €	27 €	92 €	185 €	370 €	66 €	3,318 €	879 €	517 €	C
900	18,906 €	13,076 €	13,076 €	34 €	27 €	92 €	185 €	370 €	66 €	4,193 €	963 €	546 €	C
1000	28,358 €	R	20,031 €	39 €	27 €	92 €	185 €	370 €	66 €	6,728 €	1,186 €	707 €	C
1120	35,853 €	N	23,778 €	39 €	27 €	395 €	711 €	1,186 €	395 €	8,394 €	1,352 €	979 €	C
1250	49,585 €	N	35,430 €	C	27 €	395 €	711 €	1,186 €	395 €	13,384 €	1,603 €	1,061 €	C
1400	76,649 €	N	55,831 €	C	27 €	757 €	1,212 €	2,121 €	757 €	17,963 €	1,852 €	1,186 €	C
1600	94,983 €	N	65,838 €	C	27 €	757 €	1,212 €	2,121 €	757 €	22,876 €	2,576 €	1,452 €	C
1800	120,162 €	N	86,020 €	C	C	757 €	1,212 €	2,121 €	757 €	36,298 €	6,422 €	N	C
2000	170,421 €	N	122,541 €	C	C	757 €	1,212 €	2,121 €	757 €	44,773 €	8,236 €	N	C

Ventilatoren Ein- und Auslässe



Ventilator Einlasse
0.88 mm - fb/L.fi



Ventilator Auslässe
0.88 mm - fb / D.fi

Ventilator Einlasse				
Größe (Ø mm)	Konus einlass Diameter	Einlass Flanche code	Konus code	Preis
185x8	160	HIAC000016	AAEA000028	• 72 €
205x8	180	HIAC000017	AAEA000035	• 79 €
228x8	200	HIAC000018	AAEA000043	• 91 €
255x8	225	HIAC000001	AAEA000052	• 101 €
285x8	250	HIAC000003	AAEA000062	• 109 €
320x8	300	HIAC000004	AAEA000085	• 121 €
360x8	315	HIAC000005	AAEA000098	• 134 €
405x12-8	350	HIAC000006	AAEA000112	• 152 €
455x12-8	400	HIAC000007	AAEA000127	• 172 €
505x12-8	450	HIAC000008	AAEA000142	• 189 €
565x12-16	500	HIAC000009	AAEA000156	• 212 €
635x12-16	600	HIAC000010	AAEA000180	• 269 €
715x16	650	HIAC000011	AAEA000196	• 496 €
805x16	750	HIAC000012	AAEA000244	• 419 €
905x16	850	HIAC000013	AAEA000246	• 529 €

Fan outlets			
Modell (mm)	Auslass Größe (Ø mm)	Code	Preis
131x95	160	HJEA000090	• 160 €
146x105	200	HJEA000091	• 141 €
166x117	250	HJEA000092	• 165 €
185x131	250	HJEA000093	• 165 €
207x148	250	HJEA000094	• 195 €
231x166	200	HJEA000003	• 207 €
258x185	250	HJEA000004	• 207 €
288x205	250	HJEA000005	• 232 €
322x229	300	HJEA000006	• 238 €
361x256	350	HJEA000007	• 238 €
404x288	350	HJEA000008	• 251 €
453x322	400	HJEA000009	• 268 €
507x361	450	HJEA000010	• 268 €
569x404	500	HJEA000011	• 342 €
638x453	600	HJEA000012	• 354 €
715x507	650	R	R
801x569	750	R	R
898x638	850	R	R

! Ventilatoreinlass bestehen aus einem Standard Einlassflansch und einem Standard Verzinkter Konus.
Ventilatoreinlass Preise beinhalten einen losen Flansch (L.fi) Ventilatorauslässe Preise in 1 mm beinhalten einen direkten Flansch (D.fi)

Zubehör Saugseite

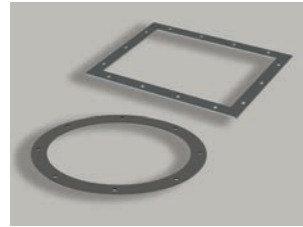

INF & OUF

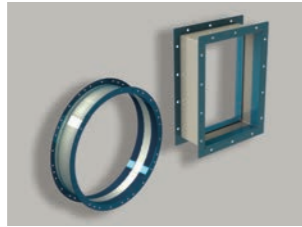

GA3 & GP3

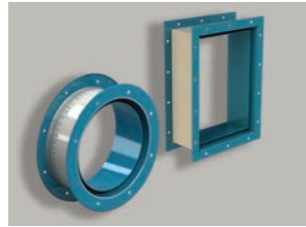

GA6 & GP6

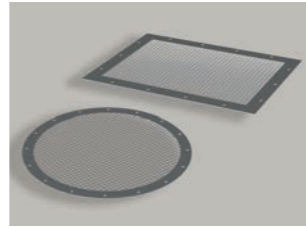

RETA & RETEM

Größe	INF		GA1		GA3		GA6		RETA	
	Code	Preis	Code	Preis	Code	Preis	Code	Preis	Code	Preis
130x4	R	R	HIBD000001	117 €	HIBA000001	269 €	HICA000001	403 €	HIDA000001	39 €
145x8	R	R	HIBD000003	118 €	HIBA000002	269 €	HICA000002	403 €	HIDA000002	45 €
165x8	R	R	HIBD000004	120 €	HIBA000003	269 €	HICA000003	403 €	HIDA000003	49 €
185x8	HIAC000016	29 €	HIBD000005	121 €	HIBA000004	269 €	HICA000004	403 €	HIDA000004	53 €
205x8	HIAC000017	32 €	HIBD000006	123 €	HIBA000005	269 €	HICA000005	403 €	HIDA000005	56 €
228x8	HIAC000018	39 €	HIBD000007	124 €	HIBA000006	269 €	HICA000006	403 €	HIDA000006	67 €
255x8	HIAC000001	45 €	HIBD000008	126 €	HIBA000007	269 €	HICA000007	403 €	HIDA000007	74 €
285x8	HIAC000003	47 €	HIBD000009	130 €	HIBA000008	269 €	HICA000008	403 €	HIDA000008	81 €
320x8	HIAC000004	52 €	HIBD000010	133 €	HIBA000009	269 €	HICA000009	403 €	HIDA000009	87 €
360x8	HIAC000005	56 €	HIBD000011	136 €	HIBA000010	284 €	HICA000010	427 €	HIDA000010	94 €
405x12-8	HIAC000006	64 €	HIBD000012	139 €	HIBA000011	316 €	HICA000011	472 €	HIDA000011	104 €
455x12-8	HIAC000007	72 €	HIBD000014	142 €	HIBA000012	350 €	HICA000012	526 €	HIDA000012	111 €
505x12-8	HIAC000008	76 €	HIBD000016	147 €	HIBA000013	379 €	HICA000013	568 €	HIDA000013	123 €
565x12-16	HIAC000009	84 €	HIBD000018	160 €	HIBA000014	442 €	HICA000014	662 €	HIDA000014	132 €
635x12-16	HIAC000010	106 €	HIBD000020	177 €	HIBA000015	491 €	HICA000015	735 €	HIDA000015	160 €
715x16	HIAC000011	136 €	HIBD000022	186 €	HIBA000016	557 €	HICA000016	832 €	HIDA000016	200 €
805x16	HIAC000012	152 €	HIBD000023	186 €	HIBA000017	631 €	HICA000017	948 €	HIDA000017	213 €
905x16	HIAC000013	186 €	HIBD000024	204 €	HIBA000018	711 €	HICA000018	1,065 €	HIDA000018	258 €
1007x24	HIAC000015	213 €	HIBD000025	211 €	HIBA000019	791 €	HICA000019	1,186 €	HIDA000019	297 €
1130x24	R	R	HIBD000026	211 €	HIBA000020	916 €	HICA000020	1,375 €	HIDA000020	388 €
1260x24	R	R	HIBD000027	237 €	HIBA000021	1,106 €	HICA000021	1,551 €	HIDA000021	487 €
1420x32	R	R	HIBD000028	255 €	HIBA000022	1,261 €	HICA000022	1,894 €	HIDA000022	595 €
1610x32	R	R	HIBD000029	264 €	HIBA000023	1,581 €	HICA000023	2,369 €	HIDA000023	752 €
1810x32	R	R	HIBD000030	281 €	HIBA000024	1,866 €	HICA000024	2,794 €	HIDA000024	892 €
2010x32	R	R	HIBD000031	301 €	HIBA000025	2,072 €	HICA000025	3,030 €	HIDA000025	1,196 €

Zubehör Saugseite in Edelstahl

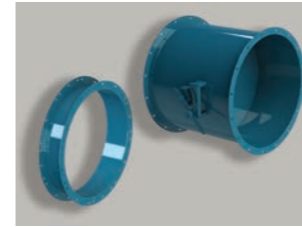

COL & VALFAR

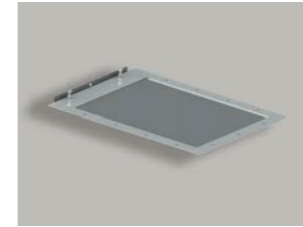

CULS

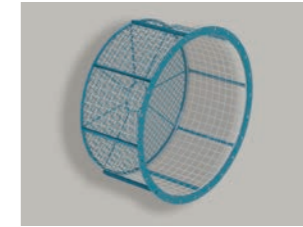

RETSA

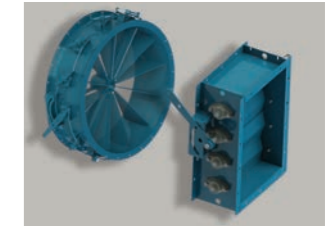

VALDAP & SERMM

AISI 304 L								
Größe	Code	INF-C	Code	RETA-C	Code	GA3-C	Code	GA6-C
180	HIAD000004	70 €	HIDB000004	69 €	HIBB000004	130 €	HICB000004	239 €
200	HIAD000005	74 €	HIDB000005	71 €	HIBB000005	134 €	HICB000005	249 €
220	HIAD000006	77 €	HIDB000006	74 €	HIBB000006	139 €	HICB000006	259 €
250	HIAD000007	91 €	HIDB000007	90 €	HIBB000007	169 €	HICB000007	314 €
280	HIAD000008	105 €	HIDB000008	98 €	HIBB000008	178 €	HICB000008	335 €
310	HIAD000009	112 €	HIDB000009	105 €	HIBB000009	185 €	HICB000009	351 €
350	HIAD000010	120 €	HIDB000010	115 €	HIBB000010	193 €	HICB000010	374 €
400	HIAD000011	143 €	HIDB000011	160 €	HIBB000011	255 €	HICB000011	501 €
450	HIAD000012	154 €	HIDB000012	178 €	HIBB000012	269 €	HICB000012	536 €
500	HIAD000013	165 €	HIDB000013	199 €	HIBB000013	281 €	HICB000013	571 €
560	HIAD000014	211 €	HIDB000014	235 €	HIBB000014	315 €	HICB000014	638 €
630	HIAD000015	279 €	HIDB000015	272 €	HIBB000015	354 €	HICB000015	718 €
710	HIAD000016	323 €	HIDB000016	391 €	HIBB000016	476 €	HICB000016	967 €
800	HIAD000017	357 €	HIDB000017	459 €	HIBB000017	511 €	HICB000017	1,051 €
900	HIAD000018	458 €	HIDB000018	545 €	HIBB000018	550 €	HICB000018	1,147 €
1000	HIAD000019	501 €	HIDB000019	637 €	HIBB000019	626 €	HICB000019	1,294 €
1120	HIAD000020	685 €	HIDB000020	833 €	HIBB000020	815 €	HICB000020	1,621 €
1250	HIAD000021	752 €	HIDB000021	1,263 €	HIBB000021	1,128 €	HICB000021	2,285 €
1400	HIAD000022	864 €	HIDB000022	1,569 €	HIBB000022	1,326 €	HICB000022	2,654 €
1600	HIAD000023	1,001 €	HIDB000023	2,003 €	HIBB000023	1,558 €	HICB000023	3,097 €
1800	HIAD000024	1,421 €	HIDB000024	2,845 €	HIBB000024	2,212 €	HICB000024	4,397 €
2000	HIAD000025	1,953 €	HIDB000025	3,907 €	HIBB000025	3,038 €	HICB000025	6,040 €

AISI 304 L								
Größe	Code	INF-D	Code	RETA-D	Code	GA3-D	Code	GA6-D
180	HIAE000029	97 €	HIDB000029	81 €	HIBB000029	154 €	HICB000029	281 €
200	HIAE000030	104 €	HIDB000030	87 €	HIBB000030	161 €	HICB000030	297 €
220	HIAE000031	111 €	HIDB000031	92 €	HIBB000031	167 €	HICB000031	312 €
250	HIAE000032	127 €	HIDB000032	112 €	HIBB000032	206 €	HICB000032	375 €
280	HIAE000033	153 €	HIDB000033	126 €	HIBB000033	223 €	HICB000033	405 €
310	HIAE000034	164 €	HIDB000034	137 €	HIBB000034	234 €	HICB000034	428 €
350	HIAE000035	181 €	HIDB000035	154 €	HIBB000035	248 €	HICB000035	461 €
400	HIAE000036	210 €	HIDB000036	223 €	HIBB000036	333 €	HICB000036	627 €
450	HIAE000037	230 €	HIDB000037	255 €	HIBB000037	356 €	HICB000037	678 €
500	HIAE000038	251 €	HIDB000038	290 €	HIBB000038	379 €	HICB000038	728 €
560	HIAE000039	330 €	HIDB000039	354 €	HIBB000039	435 €	HICB000039	819 €
630	HIAE000040	445 €	HIDB000040	416 €	HIBB000040	504 €	HICB000040	930 €
710	HIAE000041	511 €	HIDB000041	603 €	HIBB000041	679 €	HICB000041	1,253 €
800	HIAE000042	568 €	HIDB000042	722 €	HIBB000042	739 €	HICB000042	1,373 €
900	HIAE000043	743 €	HIDB000043	868 €	HIBB000043	808 €	HICB000043	1,508 €
1000	HIAE000044	819 €	HIDB000044	1,030 €	HIBB000044	937 €	HICB000044	1,709 €
1120	HIAE000045	1,112 €	HIDB000045	1,331 €	HIBB000045	1,193 €	HICB000045	2,101 €
1250	HIAE000046	1,228 €	HIDB000046	2,075 €	HIBB000046	1,733 €	HICB000046	3,021 €
1400	HIAE000047	1,397 €	HIDB000047	2,569 €	HIBB000047	2,005 €	HICB000047	3,478 €
1600	HIAE000048	1,610 €	HIDB000048	3,283 €	HIBB000048	2,334 €	HICB000048	4,039 €
1800	HIAE000049	2,288 €	HIDB000049	4,662 €	HIBB000049	3,314 €	HICB000049	5,734 €
2000	HIAE000050	3,140 €	HIDB000050	6,402 €	HIBB000050	4,550 €	HICB000050	7,875 €

Zubehör Druckseite

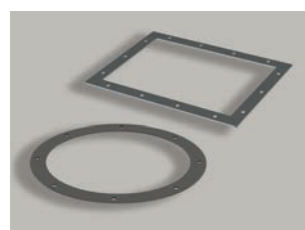

INF & OUF

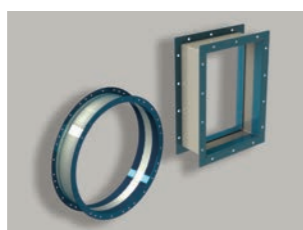

GA3 & GP3

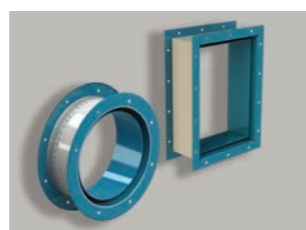

GA6 & GP6

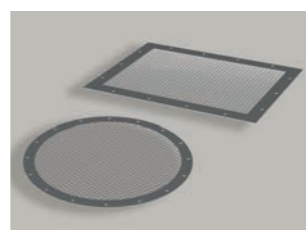

RETA & RETM

Größe	OUF		GP1		GP3		GP6		RETM	
	Code	Preis	Code	Preis	Code	Preis	Code	Preis	Code	Preis
95x68	R	R	HJBD000001	112 €	HJBA000001	225 €	HJCA000001	351 €	HJDA000001	31 €
105x76	R	R	HJBD000002	113 €	HJBA000002	225 €	HJCA000002	351 €	HJDA000002	31 €
117x85	R	R	HJBD000003	113 €	HJBA000003	225 €	HJCA000003	351 €	HJDA000003	34 €
124x103	R	R	HJBD000004	113 €	HJBA000004	225 €	HJCA000004	351 €	HJDA000004	38 €
131x95	R	R	HJBD000005	114 €	HJBA000005	225 €	HJCA000005	351 €	HJDA000005	42 €
146x105	HJAC000001	18 €	HJBD000006	115 €	HJBA000006	225 €	HJCA000006	389 €	HJDA000006	48 €
166x117	HJAC000002	18 €	HJBD000007	115 €	HJBA000007	246 €	HJCA000007	389 €	HJDA000007	52 €
185x131	HJAC000003	30 €	HJBD000008	117 €	HJBA000008	246 €	HJCA000008	389 €	HJDA000008	52 €
207x148	HJAC000004	26 €	HJBD000009	117 €	HJBA000009	269 €	HJCA000009	403 €	HJDA000009	55 €
231x166	HJAC000005	27 €	HJBD000010	119 €	HJBA000010	269 €	HJCA000010	403 €	HJDA000010	63 €
258x185	HJAC000006	29 €	HJBD000011	119 €	HJBA000011	269 €	HJCA000011	403 €	HJDA000011	70 €
288x205	HJAC000007	29 €	HJBD000012	121 €	HJBA000012	269 €	HJCA000012	403 €	HJDA000012	77 €
322x229	HJAC000008	38 €	HJBD000013	123 €	HJBA000013	269 €	HJCA000013	403 €	HJDA000013	83 €
361x256	HJAC000009	40 €	HJBD000014	125 €	HJBA000014	269 €	HJCA000014	403 €	HJDA000014	90 €
404x288	HJAC000010	52 €	HJBD000015	127 €	HJBA000015	284 €	HJCA000015	427 €	HJDA000015	98 €
453x322	HJAC000011	64 €	HJBD000016	129 €	HJBA000016	316 €	HJCA000016	472 €	HJDA000016	105 €
507x361	HJAC000012	75 €	HJBD000017	131 €	HJBA000017	350 €	HJCA000017	526 €	HJDA000017	119 €
569x404	HJAC000013	80 €	HJBD000018	139 €	HJBA000018	379 €	HJCA000018	568 €	HJDA000018	129 €
638x453	HJAC000014	96 €	HJBD000019	143 €	HJBA000019	413 €	HJCA000019	620 €	HJDA000019	153 €
715x507	HJAC000015	108 €	HJBD000020	147 €	HJBA000020	442 €	HJCA000020	662 €	HJDA000020	193 €
801x569	HJAC000016	129 €	HJBD000021	175 €	HJBA000021	475 €	HJCA000021	713 €	HJDA000021	203 €
898x638	HJAC000017	153 €	HJBD000022	172 €	HJBA000022	557 €	HJCA000022	832 €	HJDA000022	249 €
1007x715	HJAC000018	182 €	HJBD000023	178 €	HJBA000023	631 €	HJCA000023	948 €	HJDA000023	290 €
1130x801	R	R	HJBD000024	188 €	HJBA000024	791 €	HJCA000024	1,186 €	HJDA000024	377 €
1267x898	R	R	HJBD000025	197 €	HJBA000025	948 €	HJCA000025	1,422 €	HJDA000025	473 €
1421x1007	R	R	HJBD000026	207 €	HJBA000026	1,261 €	HJCA000026	1,894 €	HJDA000026	578 €
1593x1130	R	R	HJBD000027	222 €	HJBA000027	1,736 €	HJCA000027	2,369 €	HJDA000027	727 €
1786x1267	R	R	HJBD000028	235 €	HJBA000028	2,047 €	HJCA000028	2,794 €	HJDA000028	850 €
2003x1421	R	R	HJBD000029	251 €	HJBA000029	2,457 €	HJCA000029	3,357 €	HJDA000029	1,155 €
2248x1593	R	R	HJBD000030	274 €	HJBA000030	2,751 €	R	R	R	R
2521x1786	R	R	HJBD000031	295 €	HJBA000031	3,083 €	R	R	R	R
2810x2003	R	R	HJBD000032	318 €	HJBA000032	3,452 €	R	R	R	R

Zubehör Druckseite in Edelstahl

Größe	Code	AISI 304 L				Code	Code	Code
		OUF-C	Code	RETM-C	Code			
105x76	HJAD000002	56 €	HJDB000002	59 €	HJBB000002	112 €	HJCB000002	183 €
117x85	HJAD000003	59 €	HJDB000003	60 €	HJBB000003	115 €	HJCB000003	188 €
131x95	HJAD000005	62 €	HJDB000005	62 €	HJBB000005	116 €	HJCB000005	193 €
146x105	HJAD000006	66 €	HJDB000006	64 €	HJBB000006	118 €	HJCB000006	197 €
166x117	HJAD000007	70 €	HJDB000007	66 €	HJBB000007	120 €	HJCB000007	204 €
185x131	HJAD000008	74 €	HJDB000008	69 €	HJBB000008	123 €	HJCB000008	210 €
207x148	HJAD000009	78 €	HJDB000009	73 €	HJBB000009	129 €	HJCB000009	224 €
231x166	HJAD000010	91 €	HJDB000010	87 €	HJBB000010	153 €	HJCB000010	262 €
258x185	HJAD000011	97 €	HJDB000011	91 €	HJBB000011	157 €	HJCB000011	272 €
288x205	HJAD000012	112 €	HJDB000012	99 €	HJBB000012	164 €	HJCB000012	284 €
322x229	HJAD000013	120 €	HJDB000013	106 €	HJBB000013	168 €	HJCB000013	297 €
361x256	HJAD000014	130 €	HJDB000014	115 €	HJBB000014	175 €	HJCB000014	312 €
404x288	HJAD000015	168 €	HJDB000015	183 €	HJBB000015	276 €	HJCB000015	484 €
453x322	HJAD000016	181 €	HJDB000016	200 €	HJBB000016	286 €	HJCB000016	507 €
507x361	HJAD000017	195 €	HJDB000017	221 €	HJBB000017	297 €	HJCB000017	532 €
569x404	HJAD000018	336 €	HJDB000018	258 €	HJBB000018	321 €	HJCB000018	573 €
638x453	HJAD000019	368 €	HJDB000019	291 €	HJBB000019	335 €	HJCB000019	606 €
715x507	HJAD000020	438 €	HJDB000020	428 €	HJBB000020	482 €	HJCB000020	861 €
801x569	HJAD000021	554 €	HJDB000021	508 €	HJBB000021	525 €	HJCB000021	932 €
898x638	HJAD000022	781 €	HJDB000022	587 €	HJBB000022	552 €	HJCB000022	991 €
1007x715	HJAD000023	896 €	HJDB000023	731 €	HJBB000023	682 €	HJCB000023	1,205 €
1130x801	HJAD000024	1,133 €	HJDB000024	875 €	HJBB000024	776 €	HJCB000024	1,352 €
1267x898	HJAD000025	1,287 €	HJDB000025	1,352 €	HJBB000025	1,061 €	HJCB000025	1,876 €
1421x1007	HJAD000026	1,456 €	HJDB000026	1,651 €	HJBB000026	1,229 €	HJCB000026	2,163 €
1593x1130	HJAD000027	1,609 €	HJDB000027	1,961 €	HJBB000027	1,308 €	HJCB000027	2,317 €
1786x1267	HJAD000028	2,283 €	HJDB000028	2,785 €	HJBB000028	1,856 €	HJCB000028	3,291 €
2003x1421	HJAD000029	3,136 €	HJDB000029	3,825 €	HJBB000029	2,548 €	HJCB000029	4,519 €

Größe	Code	AISI 316 L				Code	Code	Code
		OUF-D	Code	RETM-D	Code			
105x76	HJAE000034	73 €	HJDB000034	66 €	HJBB000034	122 €	HJCB000034	210 €
117x85	HJAE000035	78 €	HJDB000035	69 €	HJBB000035	125 €	HJCB000035	217 €
131x95	HJAE000037	84 €	HJDB000037	71 €	HJBB000037	129 €	HJCB000037	225 €
146x105	HJAE000038	90 €	HJDB000038	74 €	HJBB000038	132 €	HJCB000038	234 €
166x117	HJAE000039	97 €	HJDB000039	78 €	HJBB000039	136 €	HJCB000039	245 €
185x131	HJAE000040	104 €	HJDB000040	83 €	HJBB000040	140 €	HJCB000040	256 €
207x148	HJAE000041	112 €	HJDB000041	88 €	HJBB000041	151 €	HJCB000041	279 €
231x166	HJAE000042	129 €	HJDB000042	106 €	HJBB000042	178 €	HJCB000042	323 €
258x185	HJAE000043	139 €	HJDB000043	113 €	HJBB000043	185 €	HJCB000043	340 €
288x205	HJAE000044	165 €	HJDB000044	127 €	HJBB000044	196 €	HJCB000044	363 €
322x229	HJAE000045	181 €	HJDB000045	140 €	HJBB000045	204 €	HJCB000045	385 €
361x256	HJAE000046	197 €	HJDB000046	157 €	HJBB000046	216 €	HJCB000046	409 €
404x288	HJAE000047	244 €	HJDB000047	245 €	HJBB000047	333 €	HJCB000047	620 €
453x322	HJAE000048	265 €	HJDB000048	274 €	HJBB000048	350 €	HJCB000048	659 €
507x361	HJAE000049	288 €	HJDB000049	311 €	HJBB000049	368 €	HJCB000049	703 €
569x404	HJAE000050	532 €	HJDB000050	374 €	HJBB000050	410 €	HJCB000050	773 €
638x453	HJAE000051	589 €	HJDB000051	433 €	HJBB000051	435 €	HJCB000051	832 €
715x507	HJAE000052	685 €	HJDB000052	633 €	HJBB000052	616 €	HJCB000052	1,163 €
801x569	HJAE000053	888 €	HJDB000053	770 €	HJBB000053	690 €	HJCB000053	1,287 €
898x638	HJAE000054	1,278 €	HJDB000054	904 €	HJBB000054	738 €	HJCB000054	1,389 €
1007x715	HJAE000055	1,453 €	HJDB000055	1,120 €	HJBB000055	890 €	HJCB000055	1,651 €
1130x801	HJAE000056	1,861 €	HJDB000056	1,369 €	HJBB000056	1,051 €	HJCB000056	1,905 €
1267x898	HJAE000057	2,103 €	HJDB000057	2,156 €	HJBB000057	1,476 €	HJCB000057	2,703 €
1421x1007	HJAE000058	2,372 €	HJDB000058	2,638 €	HJBB000058	1,694 €	HJCB000058	3,090 €
1593x1130	HJAE000059	2,636 €	HJDB000059	3,174 €	HJBB000059	1,827 €	HJCB000059	3,357 €
1786x1267	HJAE000060	3,742 €	HJDB000060	4,507 €	HJBB000060	2,594 €	HJCB000060	4,768 €
2003x1421	HJAE000061	5,139 €	HJDB000061	6,189 €	HJBB000061	3,563 €	HJCB000061	6,548 €

Oberflächenveredelung & Strukturanpassung

Ventilatoroberfläche, Einstellung und Laufrad können Sie auf Anfrage auswählen. Als Ersatzteile bieten wir Laufräder, Einlaufkegel und Gehäuse an, die separat angeboten werden.



Andere RAL Farbe Ausführung



HOTBLACK Ausführung



Feuerverzinkter Ausführung



Vollständig isoliertes Gehäuse in ex. 8



Isolierte Motorscheibe in ex. 5



Motorbock RD-LG 180

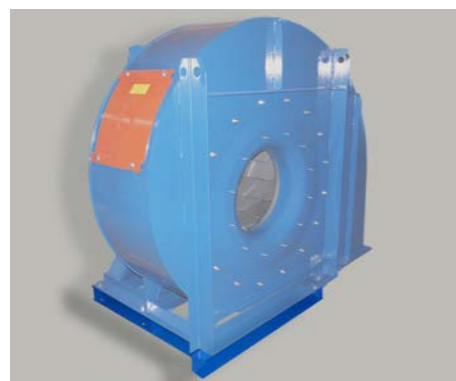

Grundrahmen für RD-LG 180



Verstärktes Ventilator Gehäuse

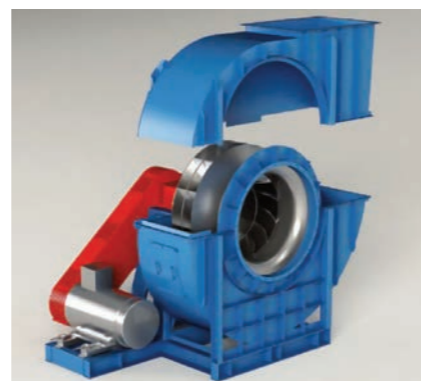

Gehäuse in zwei Teilen

Schwingungsdämpfer



Größe	RM - RL - RH - GR - G F- CA - ZM - Z					VM - ZB - VI - VG					VP - ZA - VC - VA				
	Code	Modell	Menge *	Gewinde Größe	Einheit Preis	Code	Modell	Menge *	Gewinde Größe	Einheit Preis	Code	Modell	Menge *	Gewinde Größe	Einheit Preis
200	HFAA000002	AV2-25	4	M6	13 €	-	-	-	-	-	-	-	-	-	-
220	HFAA000002	AV2-25	4	M6	13 €	-	-	-	-	-	-	-	-	-	-
250	HFAA000002	AV2-25	4	M6	13 €	-	-	-	-	-	-	-	-	-	-
280	HFAA000002	AV2-25	4	M6	13 €	-	-	-	-	-	-	-	-	-	-
310	HFAA000002	AV2-25	4	M6	13 €	-	-	-	-	-	HFAA000002	AV2-25	4	M6	13 €
350	HFAA000002	AV2-25	4	M6	13 €	HFAA000002	AV2-25	4	M6	13 €	HFAA000002	AV2-25	4	M6	13 €
400	HFAA000004	AV2-40	4	M8	20 €	HFAA000002	AV2-25	4	M6	13 €	HFAA000002	AV2-25	4	M6	13 €
450	HFAA000004	AV2-40	4	M8	20 €	HFAA000004	AV2-40	4	M8	20 €	HFAA000002	AV2-25	4	M6	13 €
500	HFAA000004	AV2-40	4	M8	20 €	HFAA000004	AV2-40	4	M8	20 €	HFAA000004	AV2-40	4	M8	20 €
560	HFAA000005	AVC-60	4	M10	38 €	HFAA000004	AV2-40	6	M8	20 €	HFAA000004	AV2-40	4	M8	20 €
630	HFAA000005	AVC-60	6	M10	38 €	HFAA000004	AV2-40	6	M8	20 €	HFAA000004	AV2-40	6	M8	20 €
710	HFAA000005	AVC-60	6	M10	38 €	HFAA000005	AVC-60	6	M10	38 €	HFAA000005	AVC-60	6	M10	38 €
800	HFAA000005	AVC-60	6	M10	38 €	HFAA000005	AVC-60	6	M10	38 €	HFAA000005	AVC-60	6	M10	38 €
900	HFAA000006	AVC-60	6	M10	38 €	HFAA000006	AVC-90	6	M16	53 €	HFAA000005	AVC-60	6	M10	38 €
1000	HFAA000006	AVC-90	6	M16	53 €	HFAA000006	AVC-90	6	M16	53 €	HFAA000006	AVC-90	6	M16	53 €
1120	HFAA000006	AVC-90	6	M16	53 €	-	-	-	-	-	HFAA000006	AVC-90	6	M16	53 €
1250	HFAA000007	AVC-120	6	M16	116 €	-	-	-	-	-	-	-	-	-	-
1400	HFAA000007	AVC-120	6	M16	116 €	-	-	-	-	-	-	-	-	-	-

* Erforderliche Menge für die Standardausführung von Ventilator ohne die Ergänzung für die Frontstütze (FS oder SOS).
 ! Es wird empfohlen, bei der Arbeit mit Silent-Blocks einen Front-Support-FS oder SOS zu verwenden. In diesem Fall müssen Sie dies tun 6 stille Blöcke.

Dichtungen



Wird als Dichtung an der Motorwelle verwendet, um ein Auslaufen nach außen zu verhindern. Je nach Arbeitsbedingungen sind mehrere Modelle verfügbar. Weitere Informationen finden Sie in den technischen Datenblättern.

Größe	TEN-N single NBR	TEN-V Single FPM	TEN-S Single Silikon	TEG ökonomisch	T2G Doppelt	T2F Doppelt/Drück	T2R Doppelt/Unterdrück	TEN-G Single Graphit	TBAD Graphitringe	TBAT PTFE beschichtet
0 : 43	111 €	127 €	140 €	84 €	179 €	179 €	179 €	141 €	836 €	836 €
44 : 58	174 €	199 €	220 €	84 €	294 €	294 €	294 €	220 €	955 €	955 €
59 : 70	276 €	315 €	349 €	105 €	339 €	339 €	339 €	332 €	1,075 €	1,075 €
71 : 110	368 €	420 €	465 €	126 €	596 €	596 €	596 €	426 €	1,613 €	1,613 €
111 : 120	431 €	493 €	545 €	126 €	745 €	745 €	745 €	507 €	1,957 €	1,957 €
121 : 150	487 €	556 €	615 €	154 €	790 €	790 €	790 €	594 €	2,271 €	2,271 €
> than 150	584 €	666 €	736 €	196 €	871 €	871 €	871 €	777 €	2,815 €	2,815 €

Motoren - allgemeine Informationen



Asynchronmotoren - (2P-4P-6P)	≤0,55kW	0,75kW-375kW
Kein ATEX-Motor ohne Frequenzumrichter	IE2	IE3
Kein ATEX-Motor mit Frequenzumrichter	IE2	IE2 or IE3
ATEX-Motor mit oder ohne Frequenzumrichter	IE2	IE2 or IE3

Gültig für S1-Motoren (Dauerbetrieb)
Für Spannungen <1 000 V und Drehzahlen 3 000 - 1 500 -1 000 (750 U / min immer IE2)
PTC enthalten

Motoren - Standard IE2 & IE3

Größe kW	Effizienz	2 pole			4 pole			6 pole		
		Code	G	Preis	Code	G	Preis	Code	G	Preis
0,18	IE2	HCBC000164	63	123 €	HCBC000168	63	132 €	HCBC000172	63	162 €
0,25		HCBC000165	63	131 €	HCBC000169	63	155 €	HCBC000173	63	180 €
0,37		HCBC000166	71	152 €	HCBC000170	71	183 €	HCBC000174	80	217 €
0,55		HCBC000167	71	166 €	HCBC000171	80	231 €	HCBC000175	80	247 €
0,75		HCBC000081	80	214 €	HCBC000107	80	266 €	HCBC000132	90S	339 €
1,1	IE3	HCBC000082	80	238 €	HCBC000108	90S	352 €	HCBC000133	90L	398 €
1,5		HCBC000083	90S	291 €	HCBC000109	90L	402 €	HCBC000134	100L	462 €
2,2		HCBC000084	90L	327 €	HCBC000110	100L	507 €	HCBC000135	112M	596 €
3		HCBC000085	100L	510 €	HCBC000111	100L	557 €	HCBC000136	132S	700 €
4		HCBC000086	112M	604 €	HCBC000112	112M	737 €	HCBC000137	132M	819 €
5,5		HCBC000087	132S	870 €	HCBC000113	132S	984 €	HCBC000138	132M	1,015 €
7,5		HCBC000088	132S	1,039 €	HCBC000114	132M	1,194 €	HCBC000139	160M	1,586 €
11		HCBC000089	160M	1,645 €	HCBC000115	160L	1,720 €	HCBC000140	180L	1,895 €
15		HCBC000090	160L	1,797 €	HCBC000116	180M	2,028 €	HCBC000141	200L	2,702 €
18,5		HCBC000091	180M	1,994 €	HCBC000117	180L	2,634 €	HCBC000142	200L	3,106 €
22		HCBC000092	200L	2,779 €	HCBC000118	200L	2,812 €	HCBC000143	225M	3,417 €
30		HCBC000093	200L	3,391 €	HCBC000119	225S	3,955 €	HCBC000144	250M	4,204 €
37		HCBC000094	225M	3,573 €	HCBC000120	225M	4,327 €	HCBC000145	280S	5,230 €
45		HCBC000095	250M	3,998 €	HCBC000121	250M	4,726 €	HCBC000146	280M	6,960 €
55		HCBC000096	280S	5,474 €	HCBC000122	280S	6,110 €	HCBC000147	315S	7,644 €
75		HCBC000097	280M	7,634 €	HCBC000123	280M	7,800 €	HCBC000148	315M	13,036 €
90		HCBC000098	315S	8,241 €	HCBC000124	315S	8,691 €	HCBC000149	315L	13,483 €
110		HCBC000099	315M	14,126 €	HCBC000125	315M	13,469 €	HCBC000150	315L	14,986 €
132		HCBC000100	315L	15,304 €	HCBC000126	315L	14,641 €	HCBC000151	315L	16,791 €
160		HCBC000101	315L	16,830 €	HCBC000127	315L	15,698 €	N	N	N
200	HCBC000102	315L	17,728 €	HCBC000128	315L	16,937 €	N	N	N	
250	HCBC000103	315	24,289 €	HCBC000129	315	27,118 €	N	N	N	

Motoren - SIEMENS IE2 & IE3

Größe kW	Effizienz	2 pole			4 pole			6 pole			
		Code	G	Preis	Code	G	Preis	Code	G	Preis	
0,37	IE2	HCBA000003	71	340 €	HCBA000028	71	349 €	HCBA000053	80	402 €	
0,55		HCBA000004	71	382 €	HCBA000029	80	388 €	HCBA000054	80	441 €	
0,75		HCBA000076	80	522 €	HCBA000100	80	560 €	HCBA000125	90S	647 €	
1,1		HCBA000077	80	591 €	HCBA000101	90S	659 €	HCBA000126	90L	790 €	
1,5		HCBA000078	90S	678 €	HCBA000102	90L	771 €	HCBA000127	100L	944 €	
2,2		HCBA000079	90L	857 €	HCBA000103	100L	952 €	HCBA000128	112M	1,162 €	
3		HCBA000080	100L	1,026 €	HCBA000104	100L	1,079 €	HCBA000129	132S	1,480 €	
4		HCBA000081	112M	1,193 €	HCBA000105	112M	1,284 €	HCBA000130	132M	1,782 €	
5,5		HCBA000082	132S	1,526 €	HCBA000106	132S	1,646 €	HCBA000131	132M	2,190 €	
7,5		HCBA000083	132S	1,887 €	HCBA000107	132M	2,031 €	HCBA000132	160M	2,724 €	
11		HCBA000084	160M	2,544 €	HCBA000108	160M	2,597 €	HCBA000133	160L	3,675 €	
15		HCBA000085	160M	3,268 €	HCBA000109	160L	3,314 €	HCBA000134	180L	4,782 €	
18,5		HCBA000086	160L	3,849 €	HCBA000110	180M	3,891 €	HCBA000135	200L	5,803 €	
22		IE3	HCBA000087	180M	4,546 €	HCBA000111	180L	4,493 €	HCBA000136	200L	6,686 €
30			HCBA000088	200L	5,848 €	HCBA000112	200L	5,772 €	HCBA000137	225M	8,473 €
37	HCBA000089		200L	7,295 €	HCBA000113	225S	6,644 €	HCBA000138	250M	10,377 €	
45	HCBA000090		225M	8,245 €	HCBA000114	225M	7,780 €	HCBA000139	280S	12,494 €	
55	HCBA000091		250M	9,843 €	HCBA000115	250M	9,310 €	HCBA000140	280M	14,626 €	
75	HCBA000092		280S	13,180 €	HCBA000116	280S	12,494 €	HCBA000141	315S	19,729 €	
90	HCBA000093		280M	15,540 €	HCBA000117	280M	14,626 €	HCBA000142	315M	22,242 €	
110	HCBA000094		315S	18,586 €	HCBA000118	315S	18,206 €	HCBA000143	315L	26,734 €	
132	HCBA000095		315M	22,242 €	HCBA000119	315M	21,403 €	HCBA000144	315L	31,683 €	
160	HCBA000096		315L	27,496 €	HCBA000120	315L	25,896 €	N	N	N	
200	HCBA000097		315L	34,273 €	HCBA000121	315L	32,064 €	N	N	N	
250	HCBA000098		315	41,884 €	HCBA000122	315	39,218 €	N	N	N	

Motoranbau*

Ventilatorabmessungen	Code	Standard Ausführung	Code	Motorschutz hohe Temperatur	Code	B3 ATEX Ausführung	Code	B5 ATEX Ausführung
180	HCCA000001	29 €	HCCB000001	74 €	HCCC000001	139 €	HCCD000001	122 €
200	HCCA000002	31 €	HCCB000002	76 €	HCCC000002	140 €	HCCD000002	123 €
220	HCCA000003	32 €	HCCB000003	77 €	HCCC000003	141 €	HCCD000003	125 €
250	HCCA000004	34 €	HCCB000004	78 €	HCCC000004	144 €	HCCD000004	126 €
280	HCCA000005	35 €	HCCB000005	81 €	HCCC000005	147 €	HCCD000005	129 €
310	HCCA000006	39 €	HCCB000006	87 €	HCCC000006	155 €	HCCD000006	134 €
350	HCCA000007	46 €	HCCB000007	91 €	HCCC000007	165 €	HCCD000007	141 €
400	HCCA000008	56 €	HCCB000008	98 €	HCCC000008	178 €	HCCD000008	154 €
450	HCCA000009	69 €	HCCB000009	113 €	HCCC000009	196 €	HCCD000009	168 €
500	HCCA000010	83 €	HCCB000010	129 €	HCCC000010	214 €	HCCD000010	182 €
560	HCCA000011	99 €	HCCB000011	150 €	HCCC000011	237 €	HCCD000011	200 €
630	HCCA000012	120 €	HCCB000012	178 €	HCCC000012	272 €	HCCD000012	228 €
710	HCCA000013	146 €	HCCB000013	213 €	HCCC000013	319 €	HCCD000013	269 €
800	HCCA000014	176 €	HCCB000014	242 €	HCCC000014	363 €	HCCD000014	304 €
900	HCCA000015	220 €	HCCB000015	301 €	HCCC000015	431 €	HCCD000015	360 €
1000	HCCA000016	272 €	HCCB000016	361 €	HCCC000016	510 €	HCCD000016	423 €
1120	HCCA000017	344 €	HCCB000017	449 €	HCCC000017	616 €	HCCD000017	606 €
1250	HCCA000018	459 €	HCCB000018	580 €	HCCC000018	767 €	HCCD000018	757 €
1400	HCCA000019	602 €	HCCB000019	738 €	HCCC000019	949 €	N	N
1600	HCCA000020	745 €	HCCB000020	924 €	HCCC000020	1,159 €	N	N
1800	HCCA000021	790 €	HCCB000021	970 €	HCCC000021	1,236 €	N	N
2000	HCCA000022	848 €	HCCB000022	1,030 €	HCCC000022	1,315 €	N	N

* Montageskosten direkt angetriebene Ventilatoren. Montageskosten der indirekt angetriebene Ventilatoren auf Anfrage.

Motoren ATEX 3GD - FUNKENFREI ExnA ATEX 3GD II T3 IP55 - B3

Größe kW	Effizienz	2 pole			4 pole			6 pole		
		Code	G	Preis	Code	G	Preis	Code	G	Preis
0,37	IE2	HCDA000077	71	348 €	HCDA000104	71	338 €	HCDA000130	80	439 €
0,55		HCDA000078	71	378 €	HCDA000105	80	470 €	HCDA000131	80	470 €
0,75		HCDA000221	80	496 €	HCDA000245	80	586 €	HCDA000269	90S	563 €
1,1		HCDA000222	80	560 €	HCDA000246	90S	599 €	HCDA000270	90L	643 €
1,5		HCDA000223	90S	555 €	HCDA000247	90L	697 €	HCDA000271	100L	892 €
2,2		HCDA000224	90L	634 €	HCDA000248	100L	849 €	HCDA000272	112M	1,125 €
3	IE3	HCDA000225	100L	892 €	HCDA000249	100L	968 €	HCDA000273	132S	1,559 €
4		HCDA000226	112M	1,060 €	HCDA000250	112M	1,207 €	HCDA000274	132M	1,716 €
5,5		HCDA000227	132S	1,574 €	HCDA000251	132S	1,605 €	HCDA000275	132M	1,979 €
7,5		HCDA000228	132S	1,765 €	HCDA000252	132M	1,819 €	HCDA000276	160M	2,681 €
9,2		HCDA000229	160M	2,154 €	HCDA000253	160M	2,265 €	N	N	N
11		HCDA000230	160M	2,880 €	HCDA000254	160L	2,930 €	HCDA000277	180L	3,104 €
15		HCDA000231	160L	3,273 €	HCDA000255	180M	3,407 €	HCDA000278	200L	3,998 €
18,5		HCDA000232	180M	3,600 €	HCDA000256	180L	4,128 €	HCDA000279	200L	4,987 €
22		HCDA000233	200L	4,408 €	HCDA000257	200L	4,423 €	HCDA000280	225M	5,450 €
30		HCDA000234	200L	5,785 €	HCDA000258	225S	5,904 €	HCDA000281	250M	8,022 €
37		HCDA000235	225M	6,446 €	HCDA000259	225M	7,392 €	HCDA000282	280S	9,437 €
45		HCDA000236	250M	7,485 €	HCDA000260	250M	8,086 €	HCDA000283	280M	11,714 €
55		HCDA000237	280S	9,159 €	HCDA000261	280S	9,708 €	HCDA000284	315S	13,111 €
75		HCDA000238	280M	11,400 €	HCDA000262	280M	12,643 €	HCDA000285	315M	23,773 €
90		HCDA000239	315S	12,842 €	HCDA000263	315S	14,016 €	HCDA000286	315L	25,625 €
110		HCDA000240	315M	22,878 €	HCDA000264	315M	22,373 €	HCDA000287	315L	29,818 €
132		HCDA000241	315L	25,263 €	HCDA000265	315L	24,039 €	HCDA000288	315L	33,703 €
160		HCDA000242	315L	26,400 €	HCDA000266	315L	26,689 €	HCDA000289	315L	47,157 €
200	HCDA000243	315L	29,039 €	HCDA000267	315L	29,787 €	HCDA000290	315L	49,747 €	
250	HCDA000244	315	49,843 €	HCDA000268	315	48,191 €	HCDA000291	315	56,323 €	

Motors ATEX 2G (Exd IIB T4 IP65)

Größe kW	Effizienz	2 pole			4 pole			6 pole		
		Code	G	Preis	Code	G	Preis	Code	G	Preis
0,37	IE2	HCDC000422	71	1,065 €	HCDC000426	71	1,081 €	HCDC000430	80	1,198 €
0,55		HCDC000423	71	1,172 €	HCDC000427	80	1,147 €	HCDC000467*	80	1,548 €
0,75		HCDC000143	80	1,305 €	HCDC000167	80	1,313 €	HCDC000189	90S	1,597 €
1,1		HCDC000144	80	1,436 €	HCDC000168	90S	1,593 €	HCDC000190	90L	1,782 €
1,5		HCDC000145	90S	1,547 €	HCDC000169	90L	1,693 €	HCDC000191	100L	2,176 €
2,2		HCDC000146	90L	1,743 €	HCDC000170	100L	2,019 €	HCDC000192	112M	2,558 €
3	IE3	HCDC000147	100L	2,176 €	HCDC000171	100L	2,422 €	HCDC000193	132S	3,742 €
4		HCDC000148	112M	2,674 €	HCDC000172	112M	3,010 €	HCDC000194	132M	4,350 €
5,5		HCDC000149	132S	3,416 €	HCDC000173	132S	3,459 €	HCDC000195	132M	5,121 €
7,5		HCDC000150	132S	4,836 €	HCDC000174	132M	5,219 €	HCDC000196	160M	5,758 €
11		HCDC000151	160M	5,849 €	HCDC000175	160L	6,187 €	HCDC000197	180L	7,587 €
15		HCDC000152	160L	6,500 €	HCDC000176	180M	6,936 €	HCDC000198	200L	11,137 €
18,5		HCDC000153	180M	7,560 €	HCDC000177	180L	8,873 €	HCDC000199	200L	11,798 €
22		HCDC000154	200L	9,934 €	HCDC000178	200L	10,613 €	HCDC000200	225M	14,650 €
30		HCDC000155	200L	12,981 €	HCDC000179	225S	13,345 €	HCDC000201	250M	19,439 €
37		HCDC000156	225M	15,232 €	HCDC000180	225M	16,398 €	HCDC000202	280S	23,908 €
45		HCDC000157	250M	19,148 €	HCDC000181	250M	18,647 €	HCDC000203	280M	30,380 €
55		HCDC000158	280S	23,547 €	HCDC000182	280S	22,939 €	HCDC000204	315S	36,197 €
75		HCDC000159	280M	30,775 €	HCDC000183	280M	30,346 €	HCDC000205	315M	48,871 €
90		HCDC000160	315S	36,693 €	HCDC000184	315S	35,599 €	HCDC000206	315L	66,347 €
110		HCDC000161	315M	47,286 €	HCDC000185	315M	47,419 €	HCDC000207	315L	73,185 €
132		HCDC000162	315L	56,823 €	HCDC000186	315L	59,206 €	HCDC000208	315L	78,541 €
160		HCDC000163	315L	64,264 €	HCDC000187	315L	69,293 €	HCDC000209	315L	92,603 €
200		HCDC000164	315L	69,916 €	HCDC000188	315L	73,783 €	HCDC000210	315L	112,000 €

* IE3

Motoren ATEX 2D - Exd IIB T4 IP65 - B3

Größe kW	Effizienz	2 pole			4 pole			6 pole			
		Code	G	Preis	Code	G	Preis	Code	G	Preis	
0,37	IE2	HCDE000025	71	479 €	HCDE000051	71	559 €	HCDE000075	80	580 €	
0,55		HCDE000026	71	522 €	HCDE000052	80	591 €	HCDE000076	80	640 €	
0,75		HCDE000098	80	671 €	HCDE000121	80	713 €	HCDE000145	90S	816 €	
1,1		HCDE000099	80	741 €	HCDE000122	90S	827 €	HCDE000146	90L	963 €	
1,5		HCDE000100	90S	844 €	HCDE000123	90L	948 €	HCDE000147	100L	1,135 €	
2,2		HCDE000101	90L	1,035 €	HCDE000124	100L	1,144 €	HCDE000148	112M	1,373 €	
3		HCDE000102	100L	1,207 €	HCDE000125	100L	1,270 €	HCDE000149	132S	1,747 €	
4		HCDE000103	112M	1,414 €	HCDE000126	112M	1,516 €	HCDE000150	132M	2,065 €	
5,5		HCDE000104	132S	1,803 €	HCDE000127	132S	1,898 €	HCDE000151	132M	2,495 €	
7,5		HCDE000105	132S	2,169 €	HCDE000128	132M	2,320 €	HCDE000152	160M	3,146 €	
11		HCDE000106	160M	2,947 €	HCDE000129	160L	3,011 €	HCDE000153	180L	4,155 €	
15		HCDE000107	160L	3,718 €	HCDE000130	180M	3,758 €	HCDE000154	200L	5,586 €	
18,5		IE3	HCDE000108	180M	4,339 €	HCDE000131	180L	4,641 €	HCDE000155	200L	6,985 €
22			HCDE000109	200L	5,340 €	HCDE000132	200L	5,277 €	HCDE000156	225M	7,923 €
30			HCDE000110	200L	7,024 €	HCDE000133	225S	6,945 €	HCDE000157	250M	10,192 €
37			HCDE000111	225M	8,534 €	HCDE000134	225M	8,173 €	HCDE000158	280S	12,337 €
45			HCDE000112	250M	9,953 €	HCDE000135	250M	9,317 €	HCDE000159	280M	15,023 €
55			HCDE000113	280S	11,781 €	HCDE000136	280S	11,383 €	HCDE000160	315S	17,408 €
75	HCDE000114		280M	15,977 €	HCDE000137	280M	15,103 €	HCDE000161	315M	23,288 €	
90	HCDE000115		315S	18,619 €	HCDE000138	315S	17,408 €	HCDE000162	315L	25,910 €	
110	HCDE000116		315M	22,016 €	HCDE000139	315M	21,619 €	HCDE000163	315L	30,757 €	
132	HCDE000117		315L	25,910 €	HCDE000140	315L	25,115 €	HCDE000164	315L	36,161 €	
160	HCDE000118	315L	31,632 €	HCDE000141	315L	29,963 €	HCDE000165	315L	43,392 €		
200	HCDE000119	315L	38,941 €	HCDE000142	315L	36,558 €	N	N	N		

Frequenzumrichter



Ausgang (kW)	Phasen	Spannung	IP20		IP55	
			Code	Preis	Code	Preis
0,75	3AC	400V	HKBA000007	1,309 €	HKBA000041	1,810 €
1,5	3AC	400V	HKBA000008	1,400 €	HKBA000042	1,940 €
2,2	3AC	400V	HKBA000009	1,546 €	HKBA000043	2,151 €
3	3AC	400V	HKBA000010	1,702 €	-	-
4	3AC	400V	-	-	HKBA000044	2,641 €
5,5	3AC	400V	HKBA000011	2,119 €	HKBA000045	2,951 €
7,5	3AC	400V	-	-	HKBA000046	3,445 €
11	3AC	400V	HKBA000012	2,432 €	HKBA000047	4,131 €
15	3AC	400V	HKBA000013	2,660 €	HKBA000048	4,986 €
18,5	3AC	400V	HKBA000014	3,056 €	HKBA000049	5,746 €
22	3AC	400V	HKBA000015	4,084 €	HKBA000050	6,694 €
30	3AC	400V	HKBA000016	5,049 €	HKBA000051	7,884 €
37	3AC	400V	HKBA000017	6,094 €	HKBA000052	9,425 €
45	3AC	400V	HKBA000018	8,019 €	HKBA000053	11,106 €
55	3AC	400V	HKBA000019	10,073 €	HKBA000054	12,691 €
75	3AC	400V	HKBA000020	12,150 €	HKBA000055	16,000 €
90	3AC	400V	HKBA000021	13,317 €	HKBA000056	18,889 €

Schallschutzhaube



Typ	Code (mit Boden)	Preis	Code (ohne Boden)	Preis
ASCI 800	HLAE000001	2,921 €	HLAF000001	1,877 €
ASCI 900	HLAE000002	3,337 €	HLAF000002	2,231 €
ASCI 1000	HLAE000003	3,924 €	HLAF000003	2,618 €
ASCI 1100	HLAE000004	4,349 €	HLAF000004	2,955 €
ASCI 1200	HLAE000005	4,860 €	HLAF000005	3,350 €
ASCI 1350	HLAE000006	5,539 €	HLAF000006	3,812 €
ASCI 1500	HLAE000007	7,586 €	HLAF000007	5,797 €
ASCI 1600	HLAE000008	8,131 €	HLAF000008	6,279 €
ASCI 1800	HLAE000009	9,380 €	HLAF000009	7,339 €
ASCI 2000	HLAE000010	10,141 €	HLAF000010	7,953 €
ASCI 2200	HLAE000011	11,361 €	HLAF000011	8,889 €
ASCI 2500	HLAE000012	12,289 €	HLAF000012	9,949 €
ASCI 2800	HLAE000013	14,711 €	HLAF000013	11,542 €
ASCI 3000	HLAE000014	15,788 €	HLAF000014	13,783 €

FA Zyklone



Zyklon Stützbeine 2mm Staubbehälter Expansionskammer

Typ	Zyklon allein			Leichter Staubsammelbehälter verzinkt 100 L		Staubbehälter 2 mm RAL5010 100 L	
	Code (links)	Code (richtig)	Preis	Code	Preis	Code	Preis
FA-20	JAAA000003	JAAA000004	2,023 €	JABY000002	893 €	JAAB000012	1,541 €
FA-35	JAAA000005	JAAA000006	2,342 €	JABY000003	893 €	JAAB000013	1,541 €
FA-50	JAAA000007	JAAA000008	2,678 €	JABY000004	893 €	JAAB000014	1,541 €
FA-65	JAAA000009	JAAA000010	4,021 €	JABY000005	893 €	JAAB000015	1,541 €
FA-100	JAAA000011	JAAA000012	5,990 €	JABY000006	893 €	JAAB000016	1,541 €
FA-130	JAAA000013	JAAA000014	12,890 €	JABY000007	1,190 €	JAAB000017	2,407 €
FA-160	JAAA000015	JAAA000016	14,965 €	JABY000008	1,190 €	JAAB000018	2,407 €
FA-180	JAAA000017	JAAA000018	24,268 €	JABY000009	1,190 €	JAAB000019	2,407 €

Typ	Einlass 2 mm RAL5010		Die Stützbeine		Expansionskammer		Beine für Expansionskammer RAL 5010	
	Code	Preis	Code	Preis	Code	Preis	Code	Preis
FA-20	JAAB000022	592 €	JAAB000002	1,114 €	JAAB000032	753 €	JAAB000042	989 €
FA-35	JAAB000023	668 €	JAAB000003	1,316 €	JAAB000033	753 €	JAAB000043	1,000 €
FA-50	JAAB000024	682 €	JAAB000004	1,316 €	JAAB000034	883 €	JAAB000044	1,165 €
FA-65	JAAB000025	682 €	JAAB000005	1,427 €	JAAB000035	1,478 €	JAAB000045	1,225 €
FA-100	JAAB000026	897 €	JAAB000006	1,567 €	JAAB000036	2,215 €	JAAB000046	1,516 €
FA-130	JAAB000027	1,594 €	JAAB000007	2,892 €	JAAB000037	5,285 €	JAAB000047	3,877 €
FA-160	JAAB000028	1,876 €	JAAB000008	3,098 €	JAAB000038	6,584 €	JAAB000048	4,072 €
FA-180	JAAB000029	2,483 €	JAAB000009	3,392 €	JAAB000039	10,050 €	JAAB000049	4,266 €

FS Zyklone



Typ	Zyklon allein			Die Stützbeine	
	Code (links)	Code (richtig)	Preis	Code	Preis
FS-3	JABA000001	JABA000002	2,738 €	JABB000001	1,264 €
FS-4	JABA000003	JABA000004	3,170 €	JABB000002	1,372 €
FS-6	JABA000005	JABA000006	4,378 €	JABB000003	1,445 €
FS-8	JABA000007	JABA000008	5,376 €	JABB000004	1,502 €
FS-11	JABA000009	JABA000010	5,971 €	JABB000005	1,534 €
FS-16	JABA000011	JABA000012	9,046 €	JABB000006	1,534 €
FS-20	JABA000013	JABA000014	9,862 €	JABB000007	1,534 €

FK Zyklone



Typ	H	Code (links)	Code (richtig)	Preis
FK1	800	JABC000001	JABC000002	502 €
FK2	830	JABC000003	JABC000004	546 €
FK3	500	JABC000005	JABC000006	533 €

RVA & RVB Zellenradschleuse

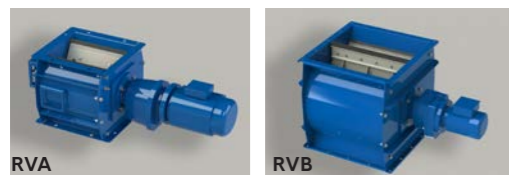

Typ	kW & rpm	Abmessungen (L x l) mm	Komplett		Set Gummiblätter (6 pcs)		Rotor komplett + Gummirotorblätter		Saugrohr
			Code	Preis	Code	Preis	Code	Preis	
RVA1-NX-06	0,37 kW - 21 rpm	250 x 220	JCAA000031	2,510 €	JCAB000001	278 €	JCAB000006	657 €	R
RVA2-NX-06	0,55 kW - 21 rpm	500 x 220	JCAA000032	3,078 €	JCAB000002	326 €	JCAB000007	979 €	R
RVA3-NX-06	0,55 kW - 21 rpm	750 x 220	JCAA000033	3,332 €	JCAB000003	414 €	JCAB000008	1,137 €	R
RVA4-NX-06	0,55 kW - 21 rpm	1000 x 220	JCAA000034	3,674 €	JCAB000004	533 €	JCAB000009	1,464 €	R
RVA5-NX-06	0,55 kW - 21 rpm	1500 x 220	JCAA000035	4,372 €	JCAB000005	711 €	JCAB000010	1,942 €	R
RVB1-NX-08	1,1 kW - 20 rpm	500 x 500	JCAC000007	6,762 €	JCAD000001	1,073 €	JCAD000004	2,947 €	R
RVB2-NX-08	1,1 kW - 20 rpm	750 x 500	JCAC000008	8,227 €	JCAD000002	1,609 €	JCAD000005	3,485 €	R
RVB3-NX-08	1,5 kW - 20 rpm	1000 x 500	JCAC000009	10,439 €	JCAD000003	2,144 €	JCAD000006	4,047 €	R

RVC Zellenradschleuse



ATEX D St1 - (IID)

Typ	kW & rpm	Abmessungen (L x l) mm	Komplett		Set Gummiblätter (6 pcs)		Rotor komplett + Gummirotorblätter		Saugrohr
			Code	Preis	Code	Preis	Code	Preis	
RVC1-X3-08	0,37 kW - 38 rpm	220 x 220	JCAE000001	R	JCAF000001	R	JCAF000004	R	R
RVC2-X3-08	0,37 kW - 18 rpm	670 x 220	JCAE000002	R	JCAF000002	R	JCAF000005	R	R
RVC3-X3-08	0,37 kW - 18 rpm	925 x 220	JCAE000003	R	JCAF000003	R	JCAF000006	R	R

RVD Zellenradschleuse



Typ	kW & rpm	# Set Gummiblätter	Gewicht	Code	Preis
RVD2-X3-06 * II 1D	0,37 kW - 27 rpm	6 *	61 Kg	JCBA000001	4,741 €
RVD2-X3-08 IID	0,37 kW - 27 rpm	8	64 Kg	JCBA000002	5,917 €

* Nicht explosionsgeschützte

Abscheider

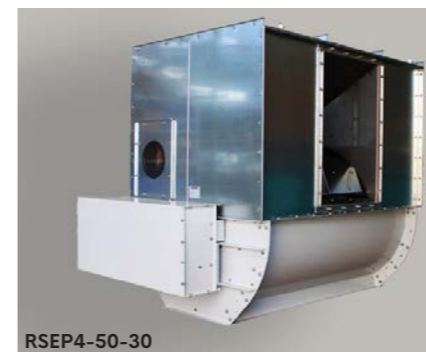

Modell (Standard)	Motor (2)	Max. m³/h	Max. kg/h (1)	Gewicht kg	Code	Preis
RSEP1-ST	0,75 kW - 3 x 230/400 V - 50 Hz	8.000	750	200	JBAA000001	R
RSEP2-ST	1,5 kW - 3 x 230/400 V - 50 Hz	22.000	2.200	480	JBAA000002	R
RSEP3-ST	2,2 kW, 3 x 230/400 V - 50 Hz	35.000	3.500	700	JBAA000003	R
RSEP4-ST	3 kW, 3 x 230/400 V - 50 Hz	50.000	5.000	1.500	JBAA000004	R
RSEP5-ST	4 kW, 3 x 230/400 V - 50 Hz	60.000	6.000	2.000	JBAA000005	R

Modell (hohe Druck)	Motor	Max. m³/h	Max. kg/h (1)	Gewicht kg	Code	Preis
RSEP2-HP	1,5 kW - 3 x 230/400 V - 50 Hz	22.000	2.200	480	JBAA000006	R
RSEP3-HP	2,2 kW, 3 x 230/400 V - 50 Hz	35.000	3.500	700	JBAA000007	R
RSEP4-HP	3 kW, 3 x 230/400 V - 50 Hz	50.000	5.000	1.500	JBAA000008	R
RSEP5-HP	4 kW, 3 x 230/400 V - 50 Hz	60.000	6.000	2.000	JBAA000009	R

(1) Legen Sie vielleicht höher, wenn getrennte Sammlung von Abfällen aus Wellpappe Produktion.
(2) 60 Hz auf Anfrage

Spitzdach für Außenmontage

Optionen			
Modell	Material	Code	Preis
RSEP2-ST to RSEP3-ST-ROOF	Painted steel	JBAB000006	R
RSEP4-ST to RSEP5-ST-ROOF	Painted steel	JBAB000007	R
RSEP2-HP to RSEP4-HP-ROOF	Painted steel	JBAB000008	R
RSEP4-HP to RSEP5-HP-ROOF	Painted steel	JBAB000009	R

XRUV flexibler Verschluss



Typ	Ø mm	Hohe mm	Ärmelweite mm	Gewicht	Code	Preis
XRUV200	200	495	356	5,0 Kg	JFCA000001	909 €
XRUV250	250	560	356	7,0 Kg	JFCA000002	1,185 €



Kontaktangaben

Formula Air Niederlande

Hauptsitz / Produktion / Verkauf
Bosscheweg 36
5741 SX Beek en Donk
Niederlande
+31 (0) 492 45 15 45
info-nl@formula-air.com

Formula Air Belgien

Logistik / Verkauf
Rue des Dizeaux 4
1360 Perwez
Belgien
+32 (0) 81 23 45 71
info-be@formula-air.com

Formula Air Baltikum

Produktion / Verkauf
P. Motiekaicio g. 3
LT-77104 Šiauliai
Litauen
+370 41 54 04 82
info-lt@formula-air.com

Formula Air Deutschland

Verkauf
Dr.-Oetker Straße 10
54516 Wittlich
Deutschland
+49 (0) 6571 269860
info-de@formula-air.com

Formula Air Frankreich – Mitte & Nord

Verkauf
Zac de la Carrière Dorée
BP 105, 59310 Orchies
Frankreich
+33 (0) 320 61 20 40
info-fr-nord@formula-air.com

Formula Air Frankreich – West

Verkauf
6, avenue des Lions
44800 Saint-Herblain
Frankreich
+33 (0) 251 89 90 75
info-fr-ouest@formula-air.com

Formula Air Frankreich – Süd

Verkauf
Chemin de Peyrecave
09600 Regat
Frankreich
+33 (0) 561 66 79 70
info-fr-sud@formula-air.com

Formula Air Nordic

Verkauf
Stortorget 17
211 22 Malmö
Schweden
+46 40 654 06 10
info-scan@formula-air.com

Formula Air Vietnam

Produktion / Verkauf
#33, Lot 2, Den Lu 1
Hoang Mai District, Hanoi
Vietnam
+84 (24) 38 62 68 01
info@vinaduct.com

Formula Air Export

Logistik / Verkauf
Rue des Dizeaux 4
1360 Perwez
Belgien
+32 (0) 81 23 45 71
info-be@formula-air.com